

VC-TA50

Auto Tracking Camera

(PTZ Video Camera)

User Manual - English

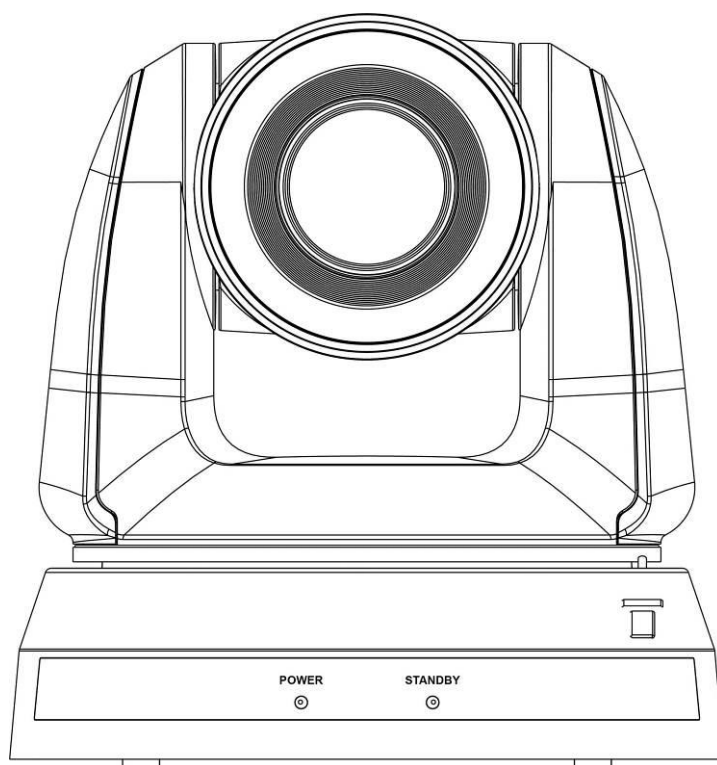

Version VCAR106

[Important]

To download the latest version of Quick Start Guide, multilingual user manual, software, or driver, etc., please visit Lumens
<https://www.MyLumens.com/support>

Table of Contents

Chapter 1	Package Contents.....	2
Chapter 2	Product Overview and Interface	3
2.1	I/O functions Introduction	3
2.2	Description of LED indicator.....	4
Chapter 3	Instruction for installation.....	5
3.1	Scenario.....	5
3.2	Camera Size.....	5
3.3	Preparation before installation	6
3.4	Instruction for installation	6
Chapter 4	Introduction of Remote Control and Setting Menu	14
4.1	Remote Control	14
4.2	Setting Menu.....	15
Chapter 5	Network Function Settings Description.....	19
5.1	Connecting Camera to Network.....	19
5.2	Web Page Menu Function Description.....	21
Chapter 6	DIP Switch Setting	35
6.1	OUTPUT Switch.....	35
6.2	IR SELECT	35
6.3	Camera Address Selector	35
6.4	System Switch.....	35
Chapter 7	Troubleshooting	36
Chapter 8	Safety Instructions	37
	Supplier's Declaration of Conformity 47 CFR § 2.1077 Compliance Information	38
	Copyright Information	39

Chapter 1 Package Contents

Camera

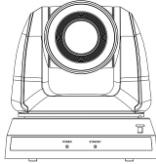

M3 Screws

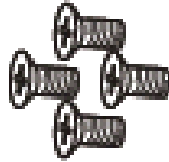

Silver x 8 / Black x 2

**RS-232/RS-422
Connection Instruction**



Remote Control



Power Adapter

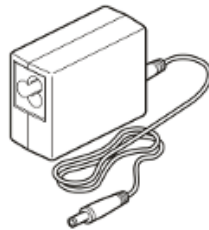

Power Cord



**Appearance may vary
depending on
country/region**

RS-422 Connector

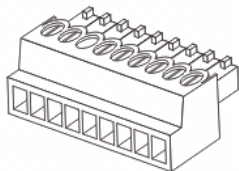

Metal Plate A

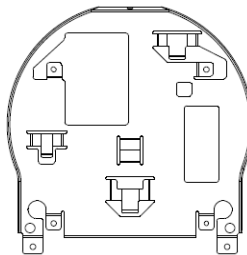

Metal Plate B

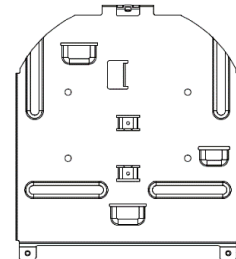

Chapter 2 Product Overview and Interface

2.1 I/O functions Introduction

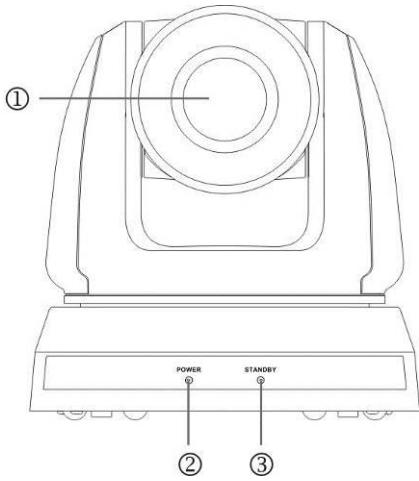

Item	Function Descriptions
1. Camera lens	HD camera lens
2. Power LED	Display the status, please refer to 2.2 Description of LED indicator
3. Standby LED	Display the status, please refer to 2.2 Description of LED indicator

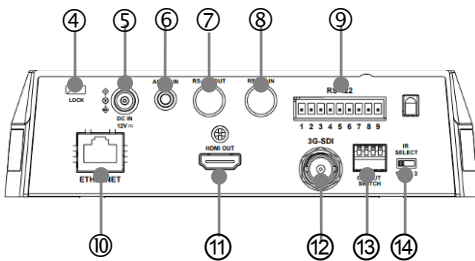

Item	Function Descriptions
4. Kensington lock hole	Safety lock slot
5. Power input	AC power supply connecting port
6. Audio In	Support Line In/Mic In
7. RS-232 output	RS-232 output port, at most 7 cameras can be connected in a serial connection
8. RS-232 input	RS-232 input port, at most 7 cameras can be connected in a serial connection
9. RS-422 connecting	RS-422 connecting port, at most 7 cameras can be connected in a serial connection
10. Network port	Support IEEE 802.3at PoE + power supply
11. HDMI output	HDMI output (support Audio output)
12. 3G-SDI	3G-SDI output
13. OUTPUT Switch	Adjust the resolution setting. The default is 1920 x 1080/60p
14. IR SELECT	Remote control ID setting It can be controlled only when it corresponds to the Camera Select on the remote control

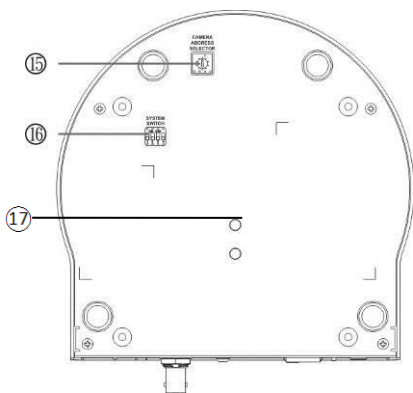

Item	Function Descriptions
15. Camera Address Selectors	Camera ID Setting
16. SYSTEM Switch	System DIP Setting
17. Tripod lock hole	The camera is mounted on a (specification) 1/4" - 20 UNC tripod

2.2 Description of LED indicator

Status	Standby	Power
Startup in progress	Green light	Orange light
In use	Green light	No indicator
In standby mode	No indicator	Orange light
Tally mode 1	Red light	Red light
Tally mode 2	Green light	Red light
Tracking Mode	Flickering green light	No indicator

<Remark> The Tally mode can be enabled via RS-232 command control. Please download the file for RS-232 Command Set from the Lumens website

Chapter 3 Instruction for installation

3.1 Scenario

3.1.1 Applicable distance range of VC-TA50: 4 - 15 m, best tracking target distance recommended: 8 m

3.1.2 Mounting height: 2 - 3 m, best height recommended: 2.4 m

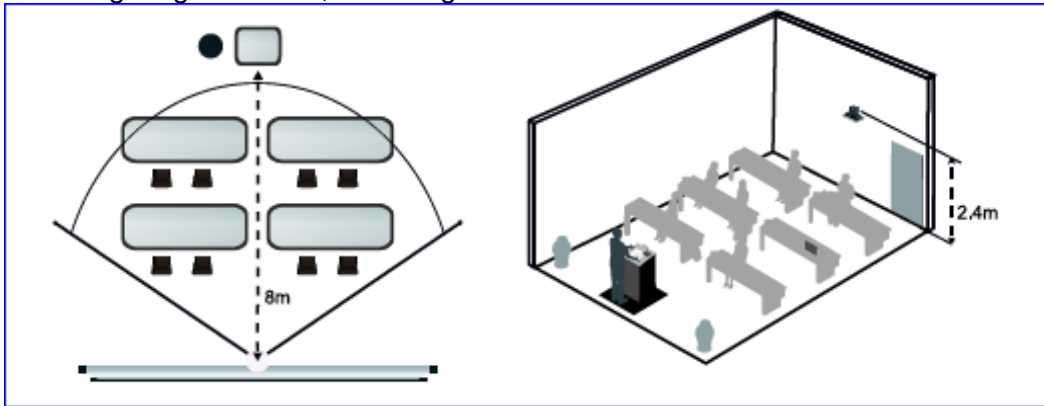

<Note> For maintaining the best tracking results, avoid images of people on posters, screens, monitors, TVs in the background

3.2 Camera Size

- Length x Width x Height: 174 x 187 x 192 mm
- Weight: 2.0 Kg

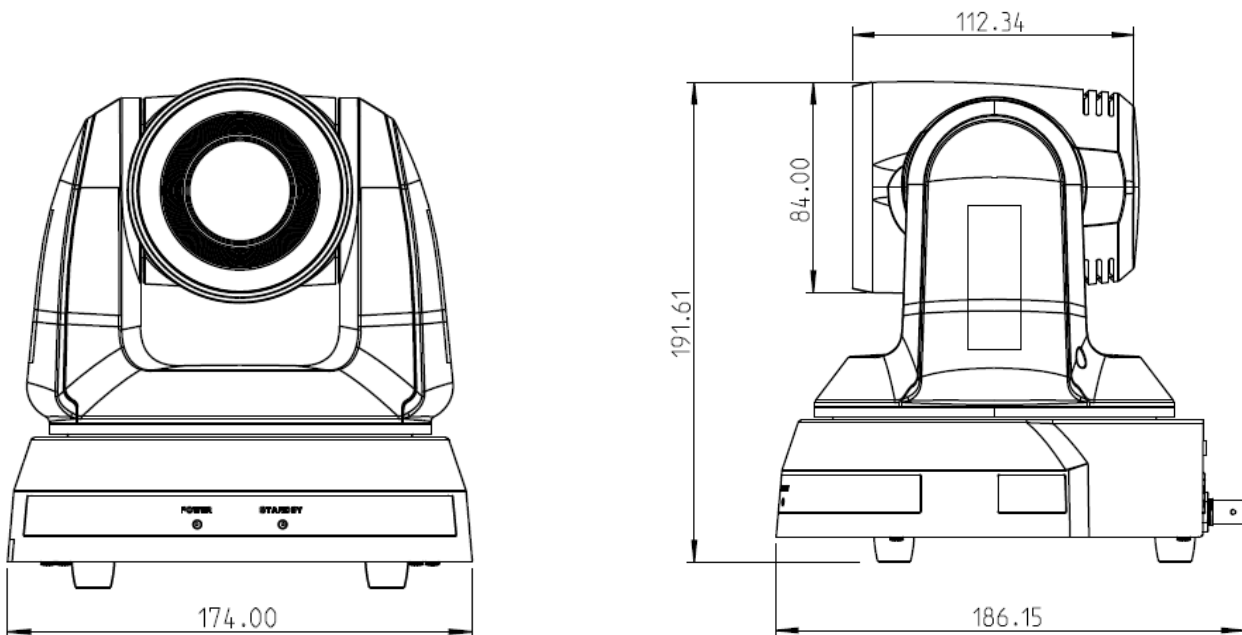

3.2.1 Dimensions of the bottom of the machine

The camera can be mounted on a 1/4"-20 UNC PTZ tripod deck by using the lock holes on the bottom for the tripod

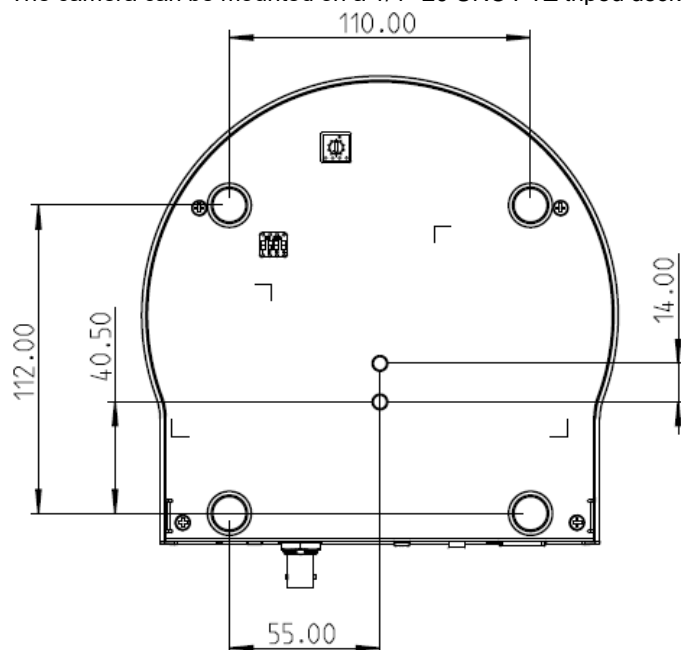

3.3 Preparation before installation

Installation and connection of HD camera requires special skills. To install by yourself, please follow necessary steps, ensure steady and tight installation of the device, and pay attention to your safety to avoid any accident.

- Ensure the safety of the installation environment. Please do not install the device on unstable ceiling or in a place where the device is in danger of falling to avoid any accident.
- Please check whether accessories in the box are complete or not. Please contact the supplier for any shortage, and make sure to keep the accessories in the box intact.
- Please choose a proper place for installation of camera in advance. Please determine an installation place according to the following requirements
 - Confirm the position for the object to be captured.
 - Confirm whether the camera is set at a proper distance from other light sources.

3.4 Instruction for installation

3.4.1 I would like to install camera on the desk

3.4.1.1 Precautions for installation

- Please install the machine on a flat desk
- Do not grab the camera head by hand when handling the device
- Do not rotate the camera head by hand. Improper rotation may result in breakdown of the camera

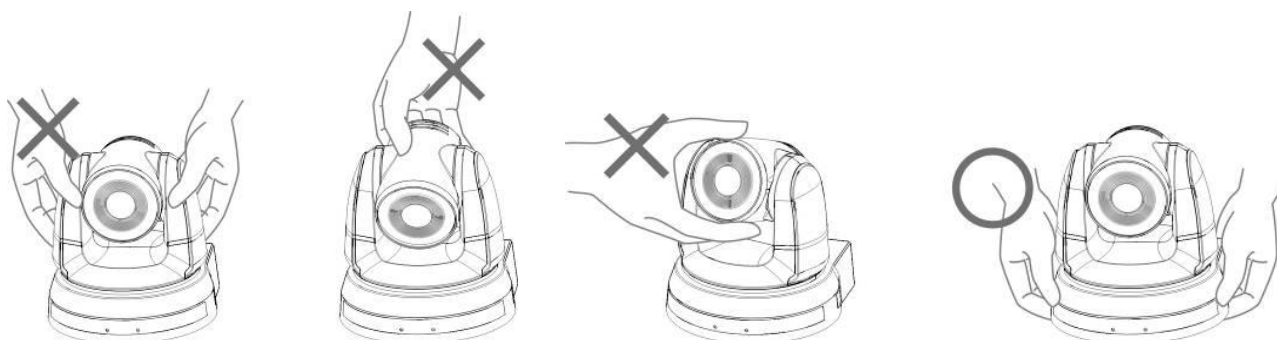

3.4.1.2 Installation steps

1. Please adjust DIP switch at first prior to installation
 - Please refer to [Chapter 6 DIP Switch Setting](#) for the relevant descriptions on DIP switch.
2. Place the camera on a flat desk directly to ensure the normal vertical and horizontal operation of the machine

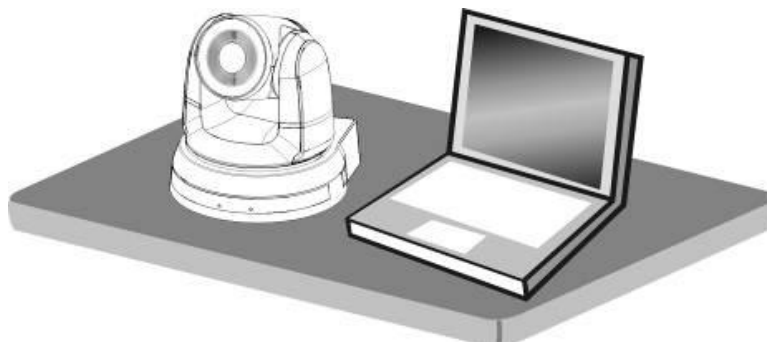

3.4.2 I would like to install the camera on the ceiling

3.4.2.1 Prepare for the parts and equipment required during the installation

- Accessories in the box (metal plates A, B, M3 screw silver x 8, black x 2)
- Screw for locking on ceiling mounted hanger x 4
- Drilling machine, screw driver, ladder

■ Metal plate B - ceiling side

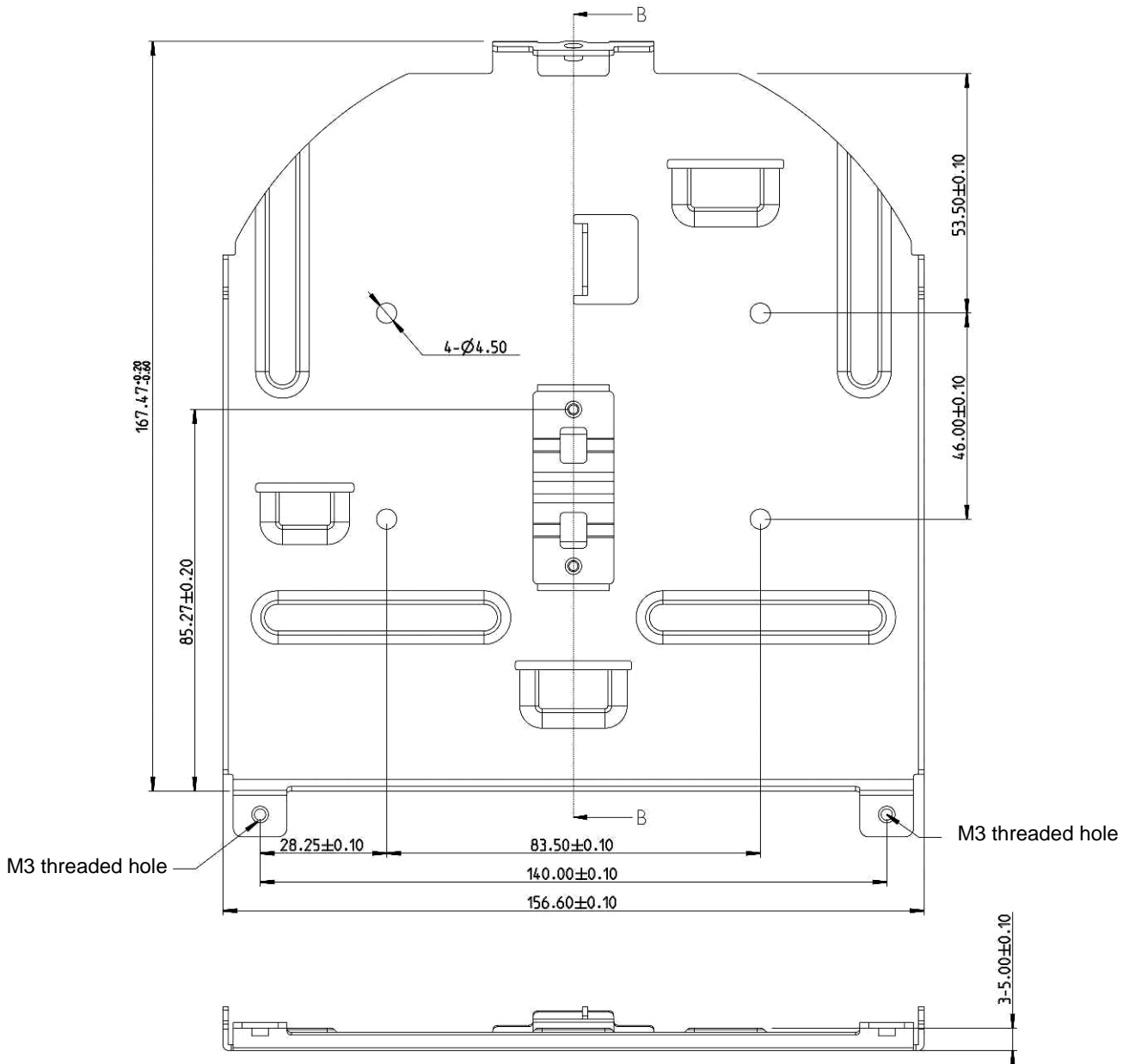
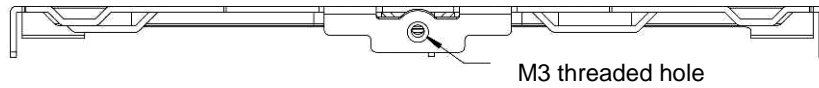
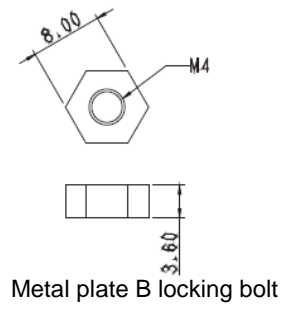
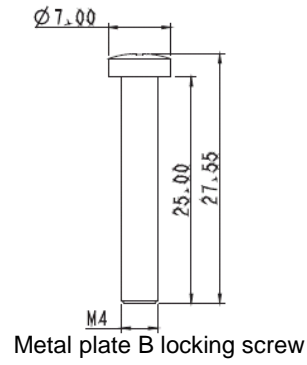

3.4.2.3 Precautions for installation

- Before installation, please confirm the orientation of the machine relative to the object to be captured
- It is recommended that the machine should be set at a distance of more than 1.5 meter away from the object to be captured. Please adjust for a best distance according to the magnification of the lens

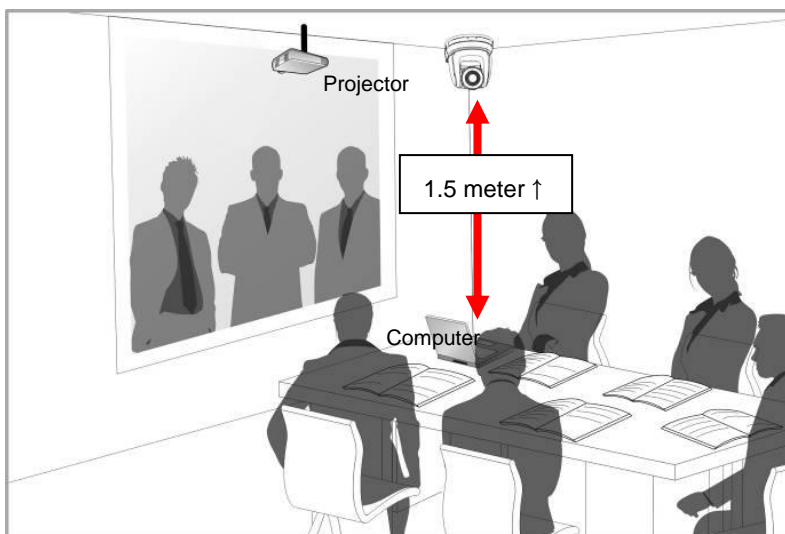

- The machine (including metal plates) is weighed at about 2.5 kg. If it is to be installed on the ceiling, please use the hanger that has obtained UL security approval to prevent the machine from falling down
- Please check whether the camera is installed securely on a regular basis

3.4.2.4 Installation steps

1. Please adjust resolution on DIP switch at first

<Remark> Please refer to [Chapter 6 DIP Switch Setting](#) for the relevant descriptions on DIP switch

2. Fix the metal plate A on the machine base with 4 M3 silver screws

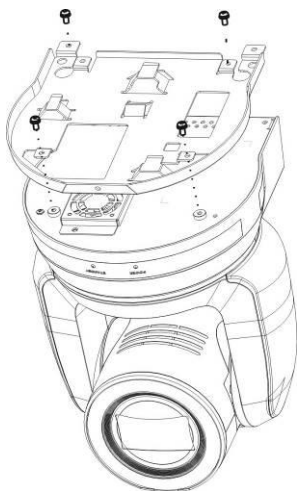

3. Lock the metal plate B on ceiling mounted hanger

- <Note> (1) Please use the hanger that has obtained UL security approval
(2) Please reserve the hole for the connecting wires of the camera

4. Combine the metal plate A and the metal plate B

- (1) Push the metal plate A up to the ceiling and then to the right to latch the metal plate B
(2) And then secure with 2 M3 silver screws and 1 M3 black screw

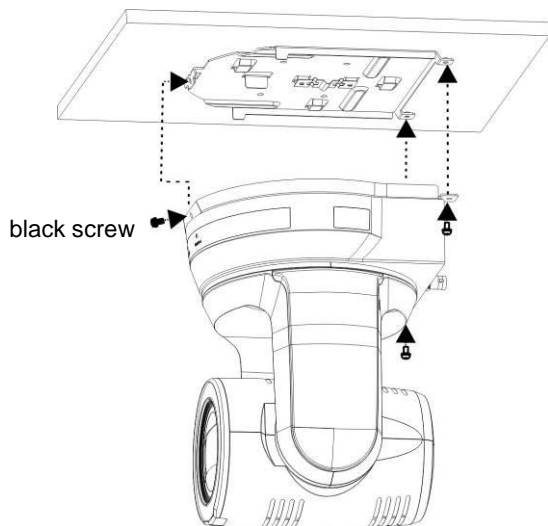

3.4.2.5 How to remove

1. Remove the connecting wires from the camera
2. Uninstall the camera together with the ceiling, loosen the three screws that fix the metal plates A and B and push to the left to remove the machine

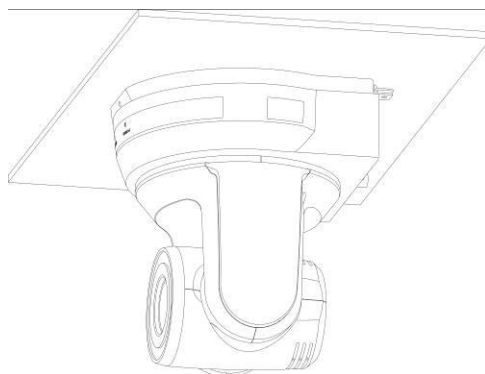

3. Then remove the screws on the hanger and the machine

3.4.3 Connecting devices

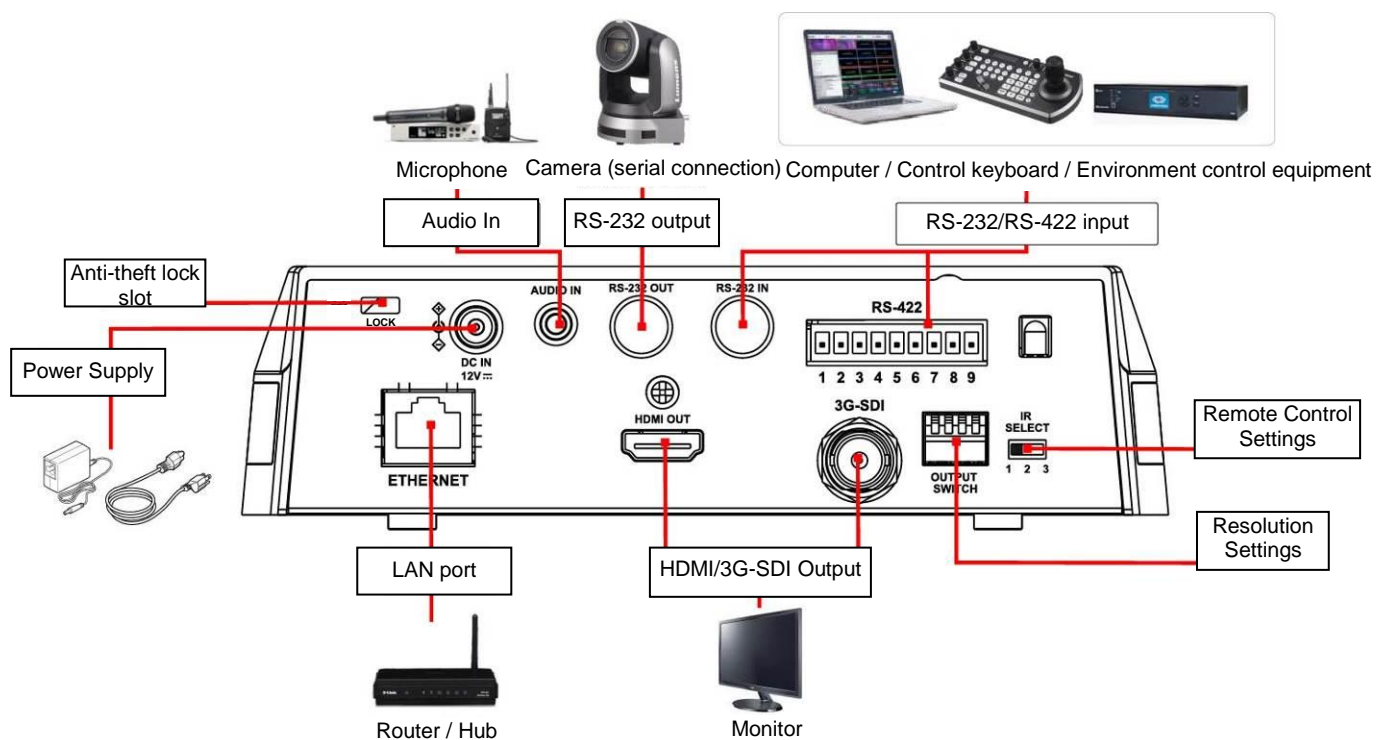

3.4.4 RS-232 connection (at most 7 Lumens cameras can be connected)

<Note> Only one of RS-422/RS-232 can be selected for control, please refer to [6.4 System Switch](#), DIP1 setting

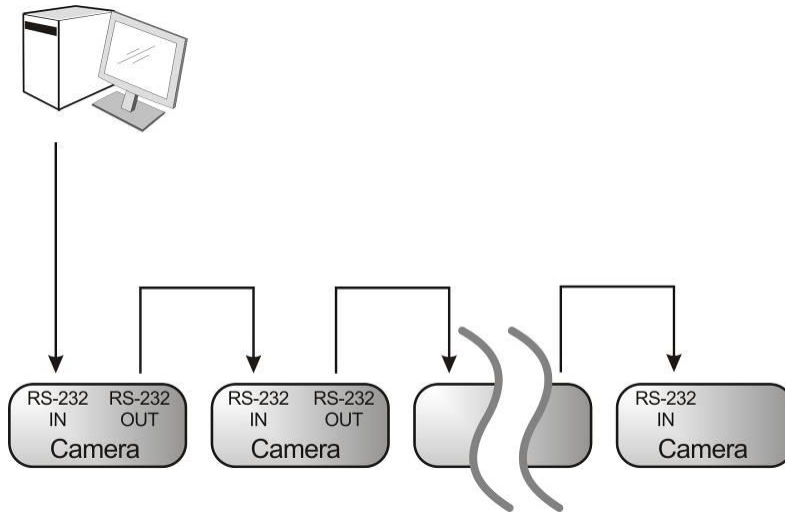

■ RS-232 pins definition instructions

▼ RS-232 IN Pins Instructions

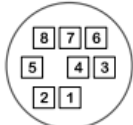

NO	Pins	Signals
1	DTR	Data Transmission Reade
2	DSR	Data Set Reade
3	TXD	Transmit Data
4	GND	Ground
5	RXD	Receive Data
6	GND	Ground
7	IR OUT	IR Commander Signal
8	N.C.	No Connection

▼ RS-232 OUT Pins Instructions

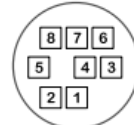

NO	Pins	Signals
1	DTR	Data Transmission Reade
2	DSR	Data Set Reade
3	TXD	Transmit Data
4	GND	Ground
5	RXD	Receive Data
6	GND	Ground
7	OPEN	Reserved
8	OPEN	Reserved

▼ RS-232 Connection Instructions

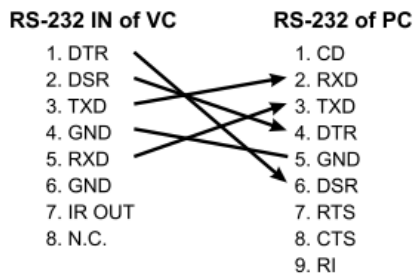

▼ RS-232 Connection Instructions

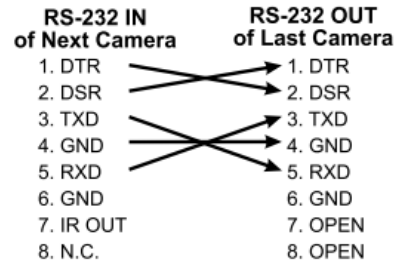

3.4.5 RS-422 connection (at most 7 Lumens cameras can be connected)

<Note> Only one of RS-422/RS-232 can be selected for control, please refer to [6.4 System Switch](#), DIP1

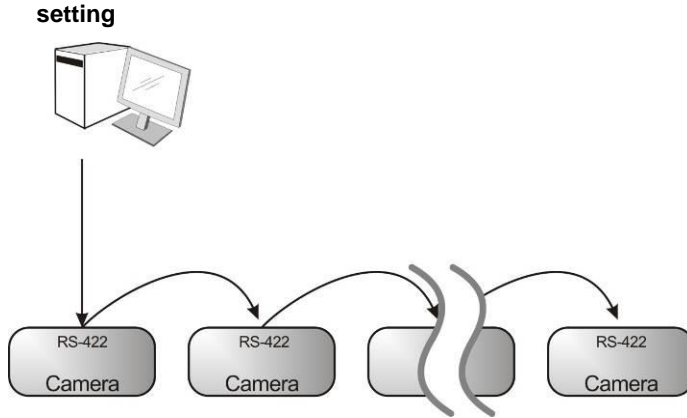

■ RS-422 pins definition instructions

▼ RS-422 Pins Instructions

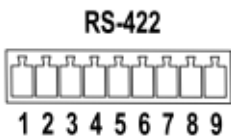

Pin NO.	Function
1	RXD OUT-
2	RXD OUT+
3	TXD OUT-
4	TXD OUT+
5	GND
6	RXD IN-
7	RXD IN+
8	TXD IN-
9	TXD IN+

▼ RS-422 Serial Connection

Up to seven cameras can be daisy-chained

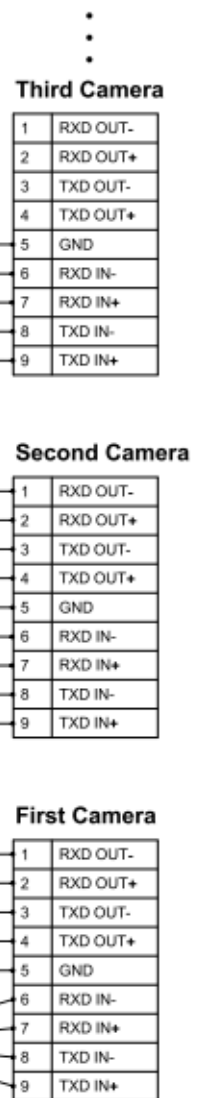

▼ RS-422 Connection Instructions

—Applicable to Lumens Compact Camera Controller

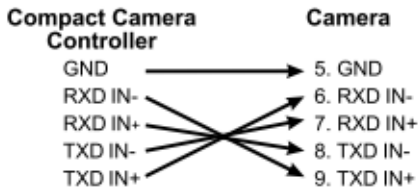

▼ RS-422 Connection Instructions

—Applicable to SONY Compact Camera Controller

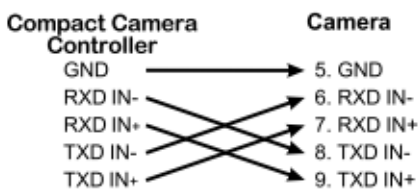

Compact Camera Controller

1	NC
2	NC
3	NC
4	NC
5	GND
6	RXD IN-
7	RXD IN+
8	TXD IN-
9	TXD IN+

First Camera

1	RXD OUT-
2	RXD OUT+
3	TXD OUT-
4	TXD OUT+
5	GND
6	RXD IN-
7	RXD IN+
8	TXD IN-
9	TXD IN+

Chapter 4 Introduction of Remote Control and Setting Menu

4.1 Remote Control

- The below functions are listed alphabetically

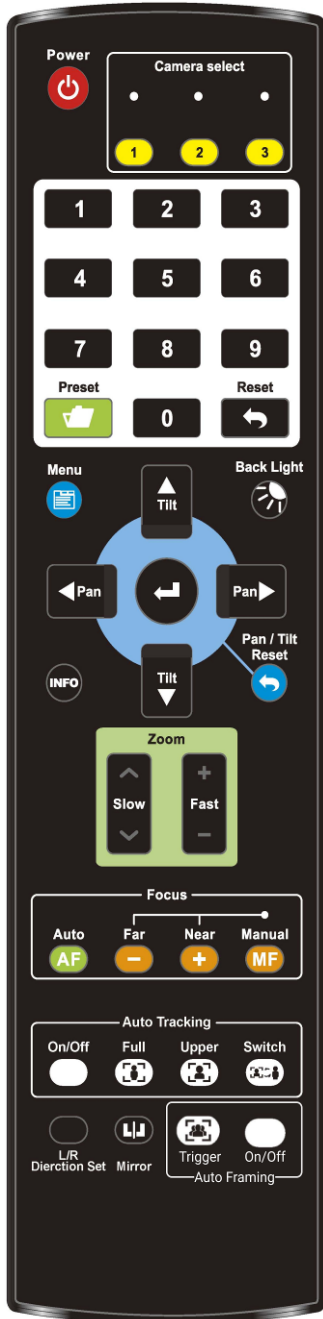

Item	Description
◀, ▶, ▲, ▼	Move the lens
Auto Tracking	<ul style="list-style-type: none"> On/Off: Enable/Disable Auto Tracking Full: Full body tracking Upper: Half body tracking Switch: Switch tracking object
Auto Framing	<ul style="list-style-type: none"> On/Off: Enable/Disable Auto Framing Trigger: Manual framing correction
Back Light	Turn on/off back light compensation
Camera select	Choose camera ID 1 ~ 3
Focus	<ul style="list-style-type: none"> Auto: Auto focus Manual: Enable Manual Focus Far/Near: Adjust the focal length in Manual
Freeze	Freeze the screen
Home-Enter	Go back to the main page / Execute
Info	Status information
L/R Direction Set	L/R Direction / Normal
Menu	Display OSD menu
Mirror	Rotate the image (OFF / Mirror / Flip / Rotate)
Pan/Tilt Reset	Clear the Pan/Tilt setting
Picture	Switch image effect (OFF / Neg / B&W)
Power	Power Switch
Preset	Appoint an ID (0 ~ 9) to save the current position data
Reset	Appoint an ID (0 ~ 9) to delete the current position data
Zoom-Fast	<ul style="list-style-type: none"> Fast: Adjust image size Slow: Fine-tune image size

4.2 Setting Menu

<Remark> Press [**Menu**] on the **remote control** to enter the setting menu; the **bold underlined** values in the following table are defaults.

1 st Level Major Items	2 nd Level Minor Items	3 rd Level Adjustment Values		Function Descriptions
Exposure	Mode	<u>Full Auto</u> / Shutter Pri / Iris Pri / Manual		Exposure mode setting
	Exposure Comp.	On / <u>Off</u>		Turn on/off Exposure Comp.
	Exposure Comp. Level	-6~ <u>C</u> ~5		The value can be adjusted after Exposure Comp. is activated
	Shutter Pri	60/ 30 mode	50/ 25 mode	Adjustable when the Exposure mode is set to Shutter Pri
		1/10000~1/1		
	Iris Pri	<u>F1.6</u> ~F6.3		Adjustable when the Exposure mode is set to Iris Pri
	Manual Gain	<u>0</u> ~45dB		Adjustable when the Exposure mode is set to Manual Pri
	Manual Speed	60/30 mode	50/25 mode	Manually set the shutter
		1/10000~1/1		
	Manual Iris	<u>F1.6</u> ~F6.3		Manually set the iris
	Gain Limit	9~ <u>C</u> ~45dB		Max. limit value of electron gain
Iris Limit	F1.6~ <u>C</u> ~F6.3		Max. limit value of iris	
WDR	<u>Off</u> / 1 / 2 / 3 / 4		WDR settings	
White Balance	Mode	1. <u>Auto</u> 2. Indoor 3. Outdoor 4. One Push WB 5. ATW 6. Manual 7. Sodium Lamp 8. 3000K 9. 4300K 10. 5000K 11. 6500K 12. 8000K 13. WideAuto		Select the color temperature mode 1. 4000k ~ 7000k 2. 3200k 3. 5800k 4. 1700k ~ 10000k 5. 1700k ~ 10000k 6. Custom 7. 2800k
	One Push Trigger	<u>ENTER</u>		One push trigger
	Manual Red	0~ <u>C</u> ~128		Adjustable when the white balance mode is set to Manual
	Manual Blue	0~ <u>C</u> ~128		Adjustable when the white balance mode is set to Manual

1 st Level Major Items	2 nd Level Minor Items	3 rd Level Adjustment Values	Function Descriptions
Tracking	Type	Auto Tracking / Auto Framing	
Picture	Picture Effect	OFF / Neg / B&W	
	Sharpness	0~ A ~15	
	2D NR	Off / Auto / 1 / 2 / 3 / 4 / 5	
	3D NR	Off / Low / Standard / Highest	
	Image Mode	Mode 1 ~ 6 / Self-defined	The user may customize his/her desired image mode
	Image Mode Load	Mode 1 ~ 6	Adjustable when the Image mode is set to Custom . After selected, the corresponding Image mode parameters will be read and applied to Custom
	Brightness	0~ C ~25	Adjustable when the Image mode is set to Custom
	Contrast	0~ C ~25	Adjustable when the Image mode is set to Custom
	Saturation	0~ C ~25	Adjustable when the Image mode is set to Custom
	Black Level	Type 1 ~ 5 / Off	Adjustable when the Image mode is set to Custom
	Gamma	0~ C ~3	Adjustable when the Image mode is set to Custom
Skin Tone	0~ C ~5		
Pan Tilt Zoom	Pan/Tilt Limit	On / Off	Turn on/off the angle limit setting
	Pan Right Limit	0~ 170	Limit the right angle
	Pan Left Limit	-170 ~0	Limit the left angle
	Tilt UP Limit	0~ 90	Limit the upward angle
	Tilt Down Limit	-30 ~0	Limit the downward angle
	Pan Flip	On / Off	After it is activated, the Pan command will be reverse
	Tilt Flip	On / Off	After it is activated, the Tilt command will be reverse
	Preset Speed	5 - C - 300 deg/sec	Set the PTZ rotation speed when Preset is performed
	PTZ Speed Comp	On / Off	Set the Pan/Tilt moving speed to vary from the zoom position
	Zoom Limit	x1 ~x20	Set the D-zoom limit
D-Effect	Mirror	OFF / Mirror / Flip / Mirror + Flip	Set the mode at which the image is turned
Auto Focus	AF Sensitivity	Low / Mid / High	For AF triggering speed, the higher the speed is, the faster AF is triggered
	AF Frame	Center Area / All Area	AF frame setting, when Central Area was set as AF frame, focusing will be on the center of the screen. When Full Frame was set as AF frame, focusing will be calculated based on the full screen
	Zoom tracking	On / Off	This function can be set in the Manual Focus (MF) mode In Manual Focus mode, check whether focus is enabled during lens zooming

1 st Level Major Items	2 nd Level Minor Items	3 rd Level Adjustment Values	Function Descriptions
	PTZ Assist	On / <u>Off</u>	This function can only be enabled in the Manual Focus (MF) mode When PTZ Assist is enabled and PTZ control is in operation, the focus will be triggered. The focus will not be triggered when the scene changes
	SMART AF	On / <u>Off</u>	Turn on this function and AF will mainly focus on the face
Ethernet	DHCP	<u>On</u> / Off	Enable/Disable the dynamic host configuration
	IP Address	<u>192.168.100.150</u>	Press [ENTER] to be in modify mode; select the item to be modified using the up and down keys, and modify the value using the left and right keys or the numeric keys.
	Subnet mask	<u>255.255.255.0</u>	
	Gateway	<u>192.168.100.254</u>	
Audio	Audio In	<u>Line In</u> / Mic In	Set Audio In
	Audio Enable	On / <u>Off</u>	Turn on/off audio output
	Audio Volume	0~ <u>C</u> ~10	Audio Volume Setting
	Audio Delay	On / <u>Off</u>	When the audio is not synchronized with the video, enable this function to set the audio delay time
	Audio Delay Time (ms)	<u>-1</u> ~500ms	Set audio delay time
	Encode Sample Rate	1. <u>48 KHz(AAC)</u> 2. 44.1 KHz(AAC) 3. 16 KHz(AAC) 4. 16 KHz(G.711) 5. 8 KHz(G.711)	Set the encode type and sample rate <Remark> SDI supports the audio output of 48 KHz only
System	Prompt	On / <u>Off</u>	Turn on/off the prompt information on the display
	IR Receive	<u>On</u> / Off	Turn on/off the infrared reception When it is Off, the remote control will not be able to control the camera. At this moment, turn off and then turn on the power to restore control of the remote control.
	Motionless Preset	On / <u>Off</u>	When the function is enabled, the screen will Freeze when Preset is executed. Freeze will be released after Preset is completed
	Tally Lamp	<u>On</u> / Off	Select Off and it will not be triggered by commands to turn on or off
	Language	<u>English</u> / Chinese	
	Initial Position	<u>Last MEM</u> / 1st Preset	Select the camera lens to return to the Last MEM or the 1st Preset after POWER ON <Remark> 1st Preset = Preset 0
	Output Mode	<u>1080p 60</u> /59.94/50/30/29.97/25 1080i 60/59.94/50 720p 60/59.94/50	Choose the output resolution
	Control Device	Encoder / <u>Controller</u>	Control Device setting, Controller: for joystick Encoder: for tracking system
	Protocol	<u>Protocol V</u> / Pelco D	Protocol V=VISCA

1 st Level Major Items	2 nd Level Minor Items	3 rd Level Adjustment Values	Function Descriptions
	Pelco D Address	<u>1</u> ~255	The Protocol set to Pelco D allows the camera ID address to be assigned
	Factory Reset	On / <u>Off</u>	Resume the factory default setting
Status			Display the current setting status

Chapter 5 Network Function Settings Description

5.1 Connecting Camera to Network

5.1.1 Connecting to Internet

Two common connection methods are shown below

1. Connecting via switch or router

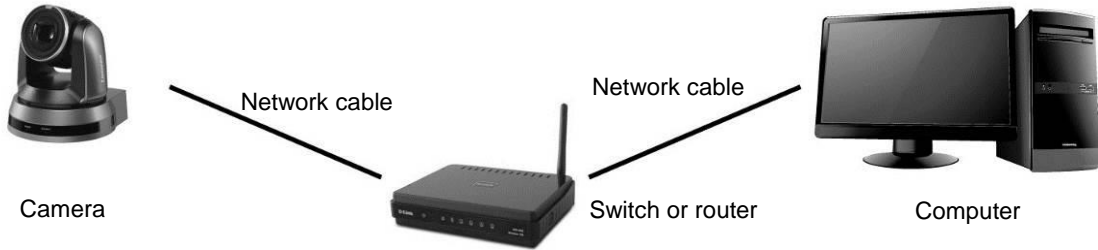

2. To connect directly through network cable, the IP address of the computer should be changed so that it is on the same network segment as the camera
E.g.: The factory-preset default IP address of the camera is 192.168.100.150. The computer IP address must be set with the same network segment, such as 192.168.100.101, so that the computer can be connected correctly with the camera

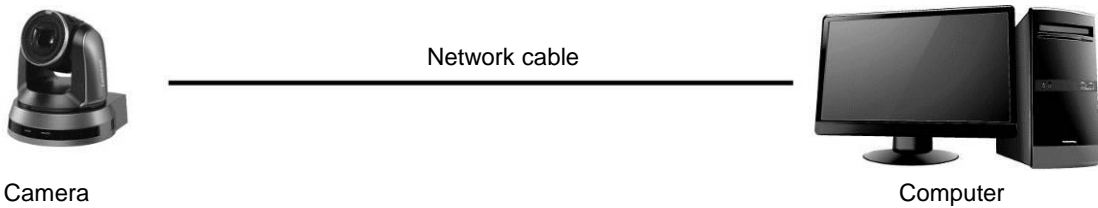

- Change network settings

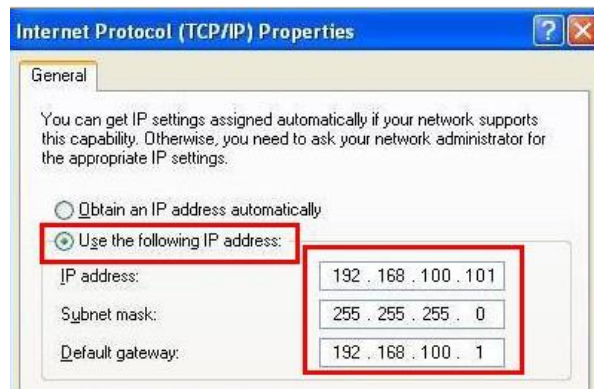

5.1.2 Using the Browser to View the Images

- Open the browser, and enter the IP address of the camera in the address bar

E.g.: <http://192.168.100.150> (default IP address)

- Enter administrator's account and password

<Remark> For the first-time login, please refer to [5.2.9 System Settings - User](#) to change the default password

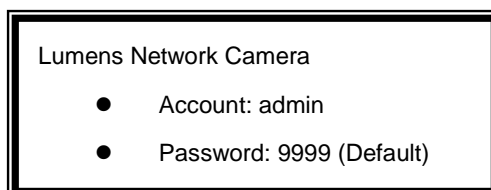
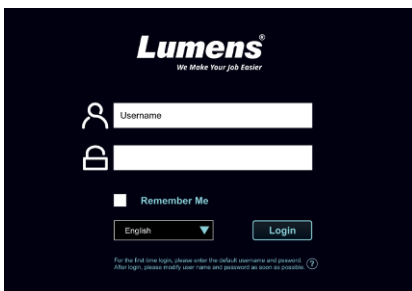

5.1.3 Using RTSP Player to View the Images

RTSP connections can be made using free software, e.g.: VLC, Quick Time, PotPlayer, etc. RTSP connection address formats are as follows:

- RTSP main stream (h264)=><rtsp://VC IP Address:8557/h264>
- RTSP second stream (h264) =><rtsp://VC IP Address:8556/h264>
- RTSP second stream (MJPEG) or single stream in MJPEG=><rtsp://VC IP Address:8555/mjpeg>

If password authentication is enabled, the RTSP connection address is as follows:

- <rtsp://Username:Password@VC IP address:port/hevc>
- <rtsp://Username:Password@VC IP address:port/mjpeg>

<Remark> To enable password authentication function, please refer to [5.2.5 Setting - Streaming](#)

Example:

Open the VLC software, click [Open Network Streaming], and enter the URL: <rtsp://192.168.100.150:8557/h264>

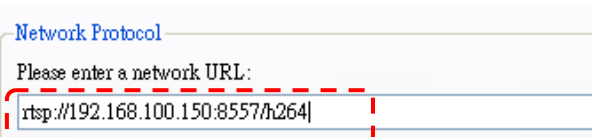
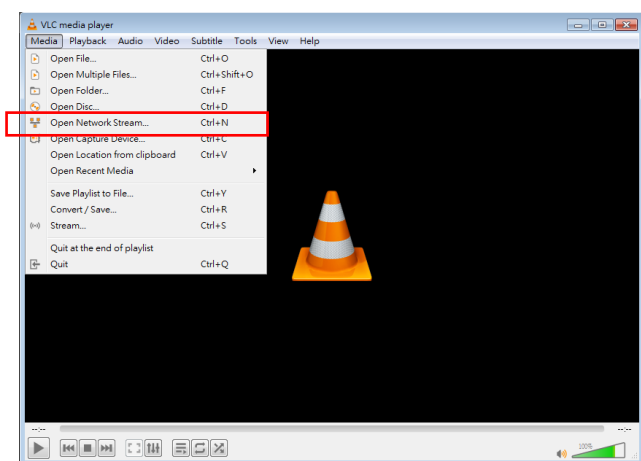

5.2 Web Page Menu Function Description

5.2.1 Login Screen

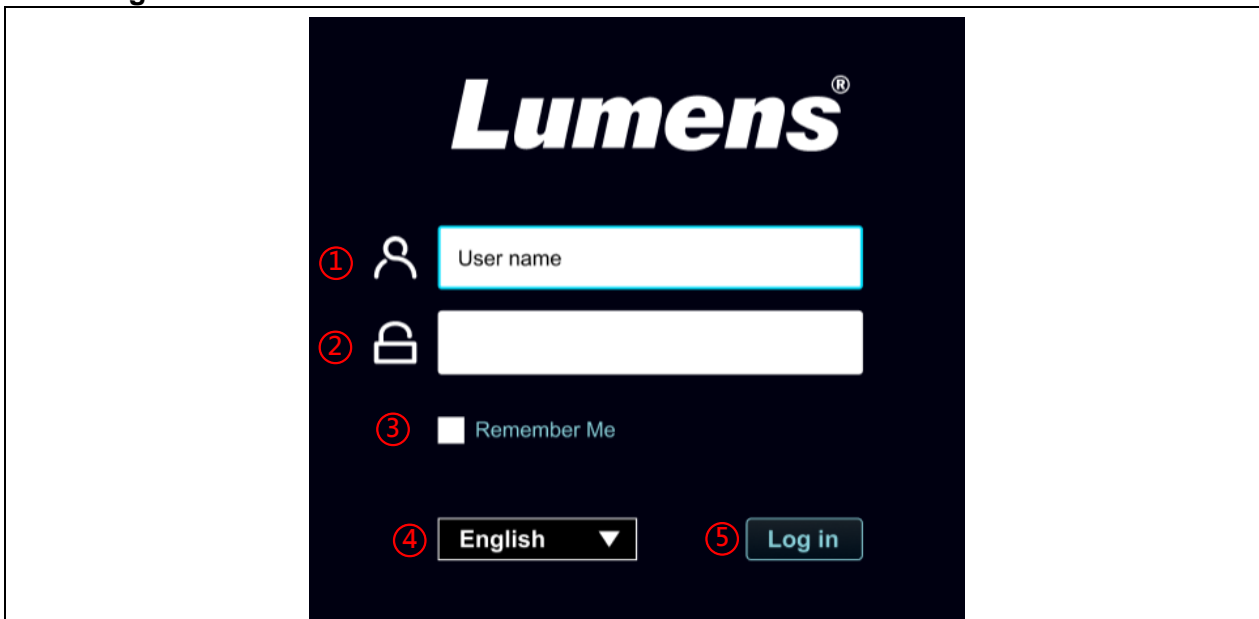

No	Item	Function Descriptions
1	User Login Account	Enter user login account (default: admin)
2	User Password	Enter user password (default: 9999) <Remark> For the first-time login, please refer to 5.2.9 System Settings - User to change the default password
3	Remember user account and password	Save user login account and password to the browser. When you log in next time, there is no need to re-enter them
4	Language	Supporting English/ Traditional Chinese/ Simplified Chinese
5	Login	Log into the administrator screen on the website

5.2.2 Live Video - PTZ Control



No	Item	Function Descriptions
1	Camera ID/location	Display camera ID/location Please refer to 5.2.6 System Settings - Device
2	Preview window	Display the screen currently captured by the camera
3	Preset setting	Select the number first and then select SAVE or LOAD
4	Pan/Tilt setting	Adjust the Pan/ Tilt position of the camera screen
5	Zoom	Zoom In/ Zoom Out ratio

6	AF/MF	Switch AF/MF
7	Camera Setting	Please refer to 5.2.2.1 Camera Setting
8	Enlarge the preview window	Zooming in/ out the preview image

5.2.2.1 Camera Setting



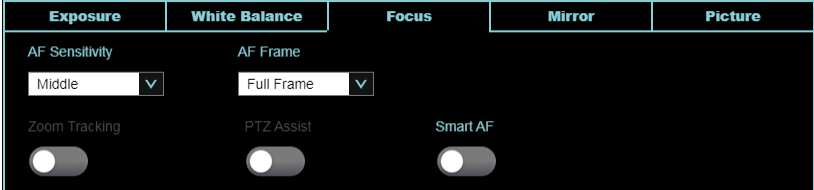
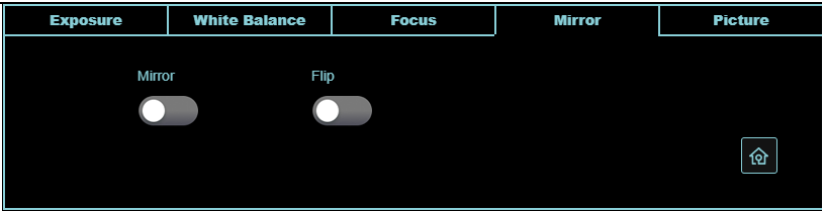

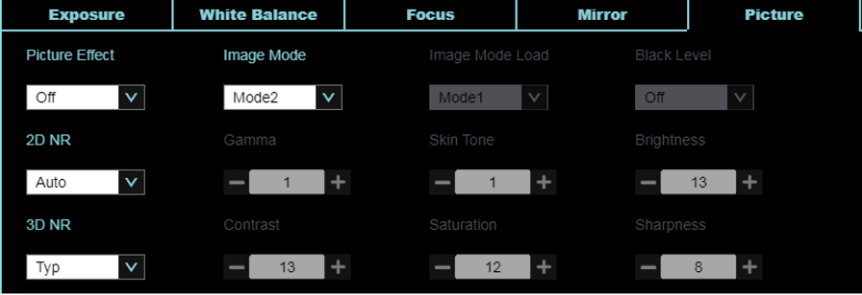

No	Item	Function Descriptions
1	Exposure	<ul style="list-style-type: none"> Mode: Select exposure mode (Full Auto / Shutter Pri / Iris Pri / Manual) Gain Level: Adjust the gain level (adjustable only under the “Manual”) Exposure Comp. Level: Select exposure compensation level WDR: Set the level of wide dynamic range (WDR) in order to obtain better images Iris Level: Adjust the size of aperture (adjustable only under the “Manual” or “Aperture Priority”) Shutter Speed: Adjust the shutter speed (adjustable only under the “Manual” or “Shutter Priority”)
2	White Balance	 <ul style="list-style-type: none"> Mode: Select the color temperature mode One Push WB: Single color temperature execution adjustment (adjustable only under the “One Push WB”) Manual Red/ Blue: Manually adjust blue/red color temperature
3	Focus	 <ul style="list-style-type: none"> AF Sensitivity: Set automatic focus sensitivity AF Frame: Set automatic focus range Zoom Tracking: Check whether focus is enabled during lens zooming (can be set in Manual) PTZ Assist: Check whether auto focus is enabled if there is any changes of PTZ (can be set in Manual) <Remark> When PTZ Assist is enabled and PTZ control is in operation, the focus will be triggered. The focus will not be triggered when the scene changes Smart AF: AF will mainly focus on the face
4	Mirror	 <ul style="list-style-type: none"> Mirror: Set image mirroring Flip: Set the mirror/flip mode

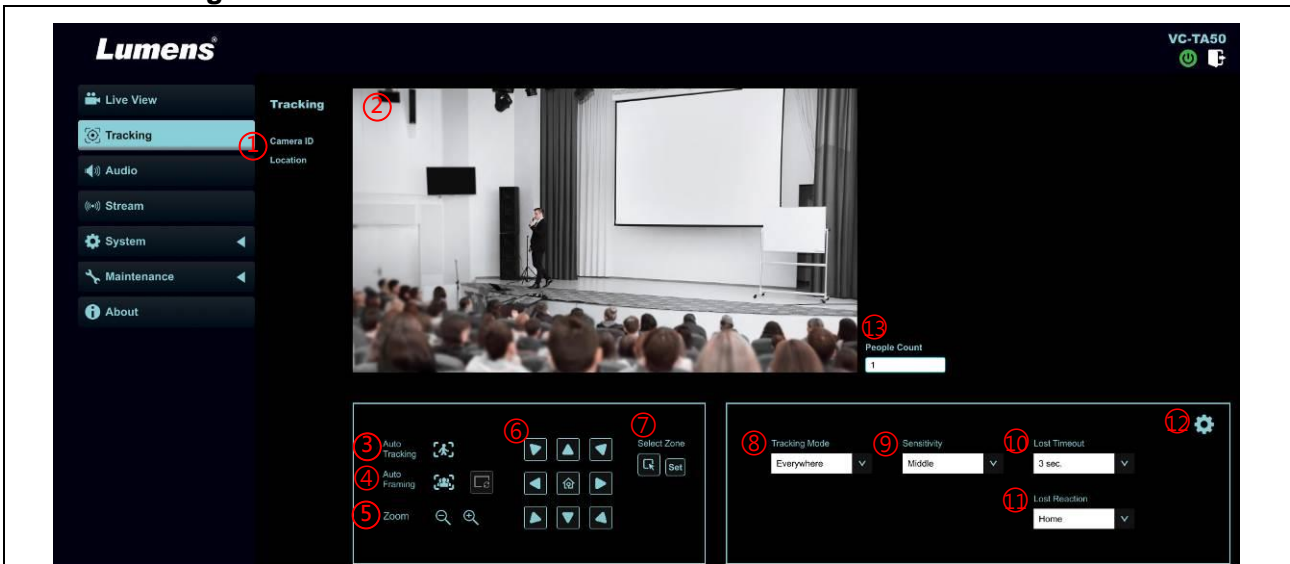
5	Photo	 <ul style="list-style-type: none"> ■ Image Effect: Set picture effect, Off/Neg/Black and White ■ Image Mode: The user may customize his/her desired image mode ■ Image Mode Load: Adjustable when the Image mode is set to Custom. After selected, the corresponding Image mode parameters will be read and applied to Custom ■ 2D noise reduction: 2D noise reduction settings ■ 3D noise reduction: 3D noise reduction settings ■ Gamma: Gamma Level adjustment (Adjustable when the image mode is set to Custom) ■ Black Level: Black Level adjustment (Adjustable when the image mode is set to Custom) ■ Skin Tone: Skin Tone adjustment (Adjustable when the image mode is set to Custom) ■ Brightness: Brightness adjustment of the image (Adjustable when the image mode is set to Custom) ■ Contrast: Contrast adjustment (Adjustable when the image mode is set to Custom) ■ Saturation: Saturation adjustment of the image (Adjustable when the image mode is set to Custom) ■ Sharpness: Adjust the sharpness of the image
6	PTZ Control	Go back to PTZ Control page

5.2.3 Tracking



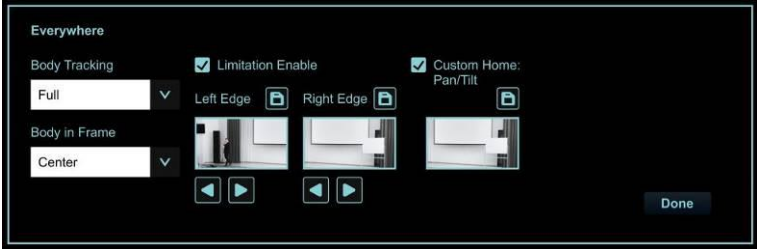

No	Item	Function Descriptions
1	Camera ID/ location	Please refer to 5.2.6 System Settings - Device to display camera ID/ location
2	Preview window	Display the screen currently captured by the camera <Remark> Left-click the detected person in the screen to switch the tracking object. The tracking object is depicted with a green bounding box
3	Auto Tracking	Start/ Stop Auto Tracking
4	Auto Framing	Start/ Stop Auto Framing The camera will automatically detect the locations of people, and automatically adjust the zoom to the most appropriate size to accommodate all the participants

		according to change of the number of people in conference <Remark> If the image is not zoomed according to the actual number of people, please click  to perform framing correction.
5	Zoom ratio	Zoom In/ Zoom Out ratio
6	Pan/Tilt setting	Adjust the Pan/ Tilt position of the camera screen
7	Select Zone	Click  and drag the mouse to select an area and then click Set , the screen will be enlarged to the selected zone Click Set again to cancel enlarging the selected zone
8	Tracking Mode	Set the Tracking Mode (Everywhere/ Stage/ Partition/ Framing)
9	Sensitivity	Set tracking sensitivity
10	Lost Timeout	Set a delay for taking action after a tracking object is lost
11	Lost Reaction	Set the action after a tracking object is lost
12.1	Settings - Everywhere tracking	 <ul style="list-style-type: none"> ■ Border Limitation Enable: ■ Everywhere Body Tracking: Set Full/Half Body ■ Body in Frame: Set the position of the person in the screen (Center/Left/Right) ■ Custom Home: When “Lost Reaction” is set as “Return”, you can customize the return position (only Pan/Tilt is memorized)
12.2	Settings - Stage Tracking	<p>Set the left/right border of the stage. Please refer to 5.2.3.1 Stage Tracking for the setting steps</p>  <ul style="list-style-type: none"> ■ Custom Home: When “Lost Reaction” is set as “Return”, you can customize the return position (only Pan/Tilt is memorized)
12.3	Settings - Partition Tracking	<p>Set Partition Tracking. Up to 4 zones can be set. When a person enters the zone of a partition, the camera switches to the partition. Tracking is not performed in the zone, but everywhere outside the partition Please refer to 5.2.3.2 Partition Tracking for the setting steps</p>  <ul style="list-style-type: none"> ■ Partition Settings: Edit, save partition positions and preview the partition image. Click to enlarge the partition image, and then click the enlarge icon to cancel the preview. ■ Number of Partitions: Set the number of partitions ■ Home Partition: Set the initiate partition position
13	People Count	Display the number of people in the screen automatically calculated by the system

5.2.3.1 Stage

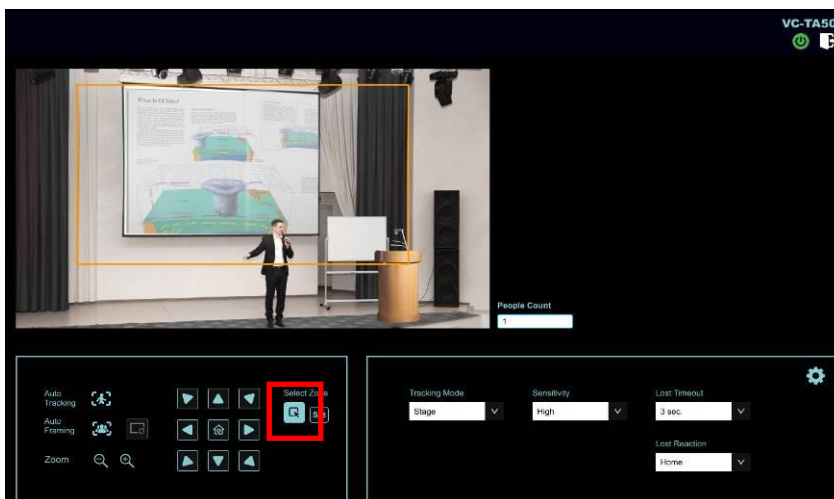



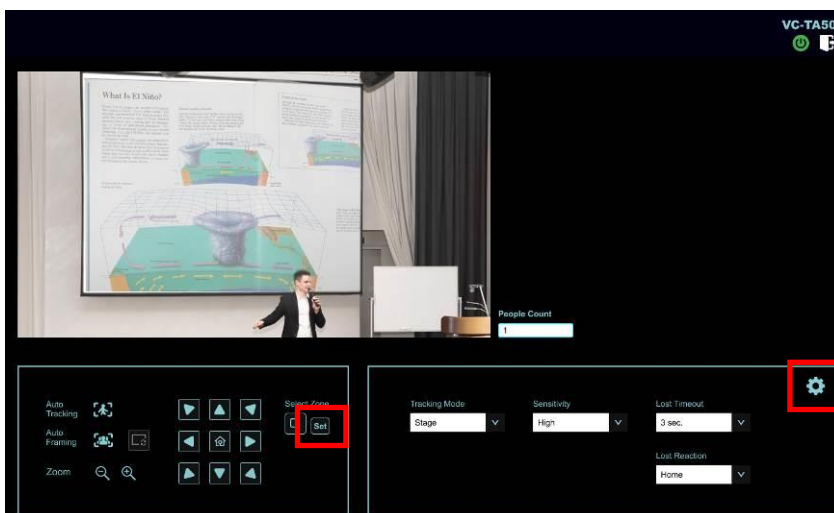

1. Select [Stage] for Tracking Mode, and click  box to select an area (orange box)



2. After the selection, click  to set, and the preview screen will display the selected area, then click  to access the settings



3. Set the Left/Right Border

- Left Border: Click   to move the position and click  when finished
- Right Border: Click   to move the position and click  when finished
- Click  to complete the settings after setting the left/right border

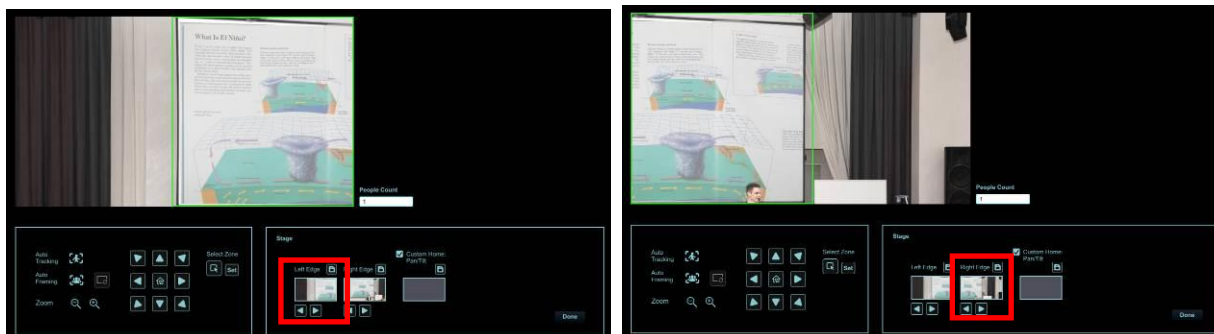

4. Click  to enable the Stage feature

5.2.3.2 Partition

1. Select [Partition] for Tracking Mode, and click  to access the settings

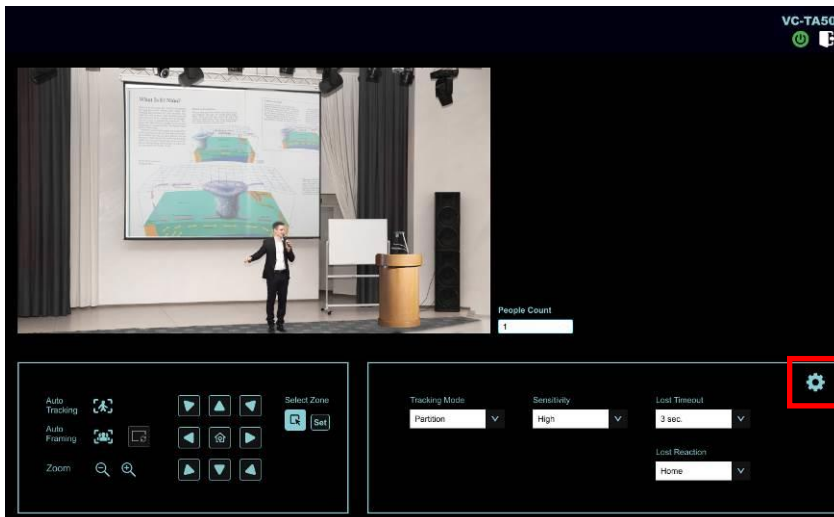

2. Use PTZ function to adjust to the screen to be partitioned, and then click  to save. The partition icon below will be changed to the saved position

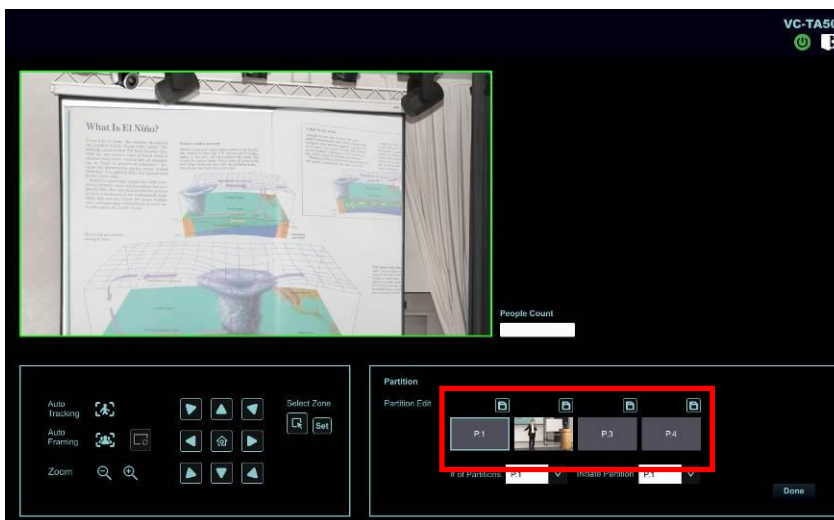

3. If you need to set other partitions, please continue using PTZ function to adjust the screen, and then click  to save

<Remark> If a red box is displayed when adjusting the screen, it means that the position overlaps with that of other partitions. Please adjust the screen again and save it when a green box is displayed

<Remark> Overlapping partition positions may cause abnormal tracking behavior

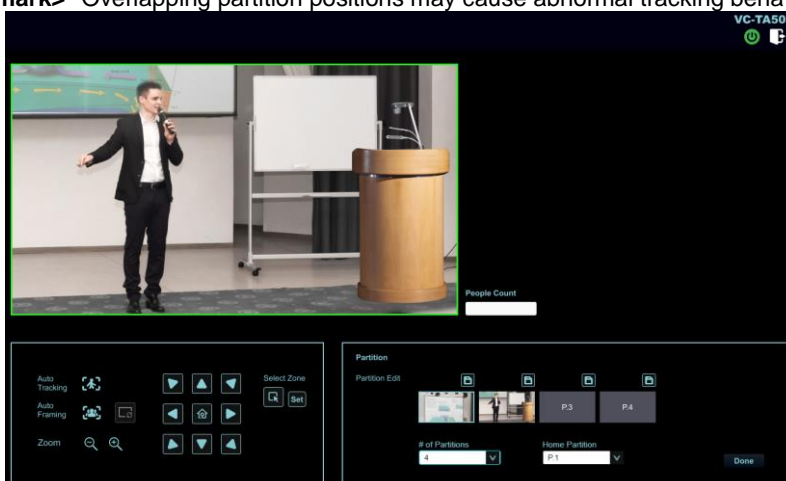

4. Click  to enable the Partition feature

5.2.4 Audio

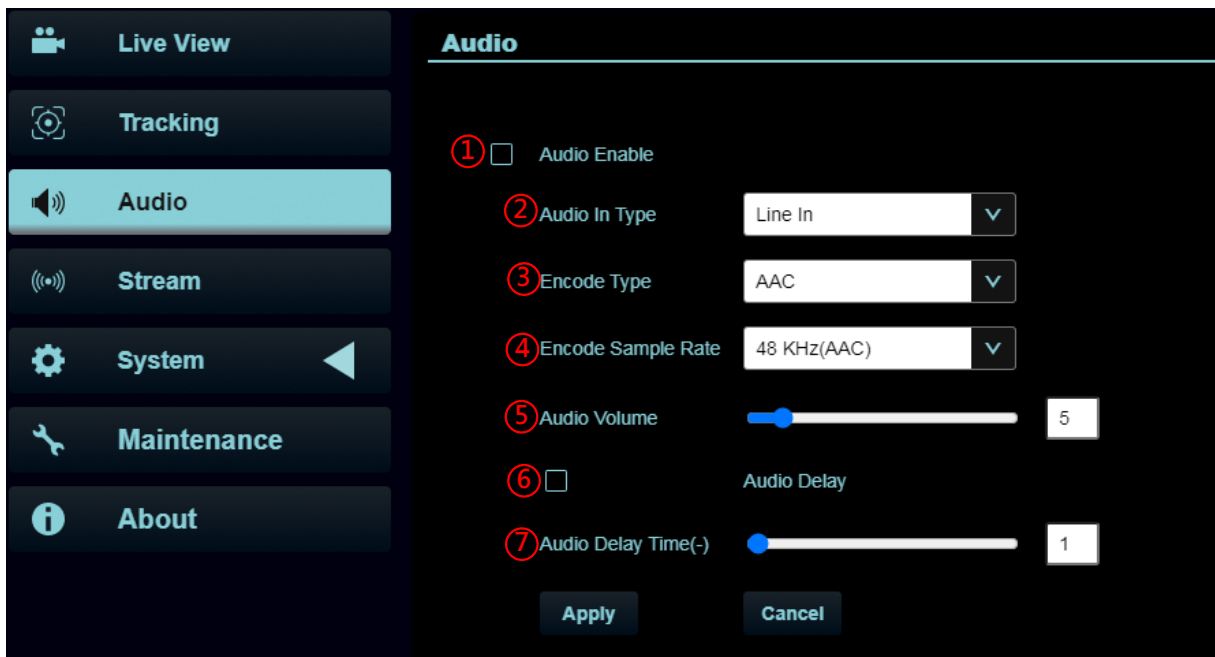

No	Item	Function Descriptions
1	Audio Enable	Turn on/ off sound
2	Soundtrack effect setting	Set MIC In/ Line In
3	Encode Type	AAC / G.711
4	Encode sample rate	Set Encode sample rate <ul style="list-style-type: none"> ■ 48 KHz (AAC) ■ 44.1 KHz (AAC) ■ 16 KHz (G.711) ■ 8 KHz (G.711) <Remark> SDI supports the audio output of 48 KHz (AAC) only
5	Audio Volume	Adjust Audio Volume
6	Audio Delay	Turn on/ off audio delay
7	Audio Delay Time	Set the audio signal delay time (-1 ~ -500 ms)

5.2.5 Streaming

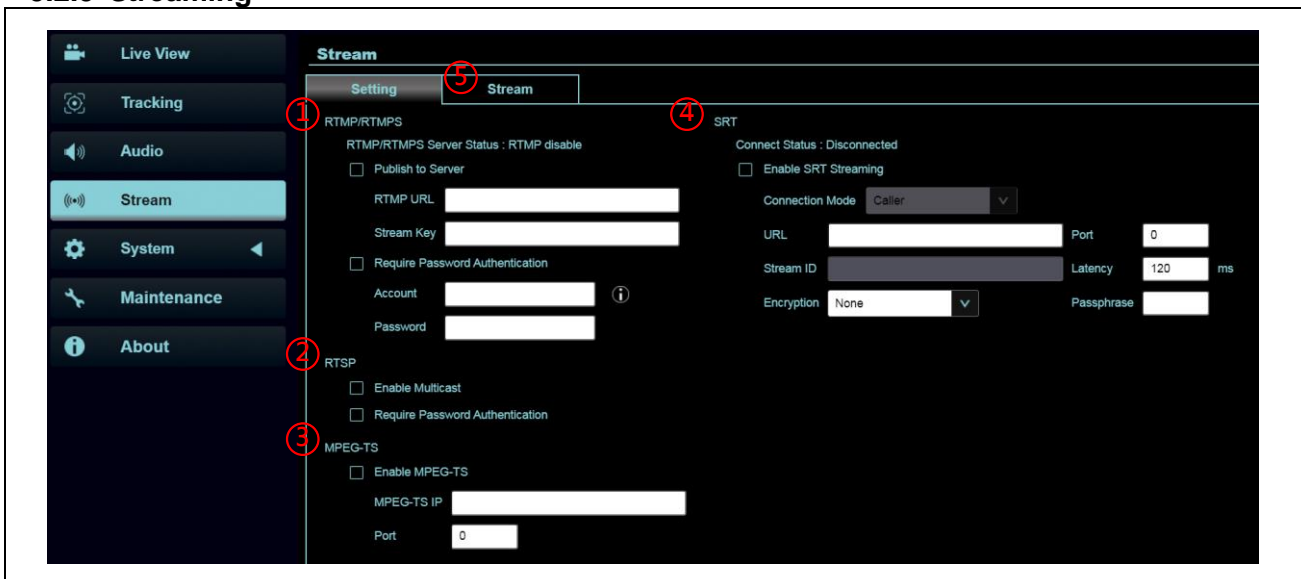

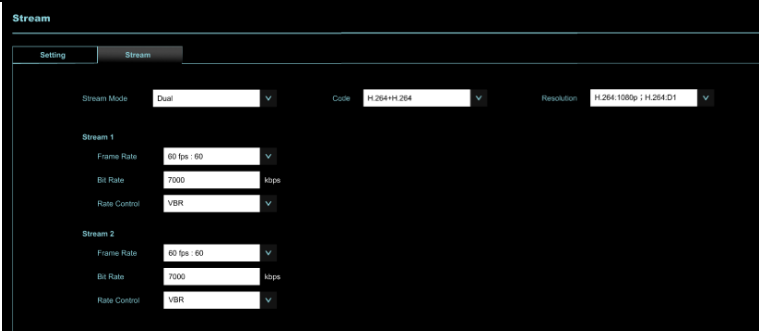
No	Item	Function Descriptions
1	RTMP/RTMPS Setting	Copy the RTMP web address provided by the RTMP service platform and paste it to the RTMP connection address to publish the camera images on the RTMP service platform To upload to YouTube for live streaming, please refer to 5.2.4 Settings - Audio to turn on the audio function
2	RTSP Setting	<ul style="list-style-type: none"> ■ Enable/Disable Multicast It is suggested to enable Multicast when the number of users online watching the image simultaneously is more than 4 ■ Enable/Disable Password Authentication <ul style="list-style-type: none"> ➢ RTSP connection format can be found in 5.1.4 Using RTSP Player to View the Images ➢ The username/password is the same as the web login password of the camera, please refer to 5.2.9 System Settings - User to add/modify account information
3	MPEG-TS Setting	Set MPEG-TS format <Remark> Port must be set above 1024 <Remark> The following port has been used by the camera. Setting of the port may not connect correctly 8554, 8556, 8557, 8080, 80, 81, 9090, 23
4	SRT Setting	1. Set the field of SRT and then check the item to open SRT streaming After the SRT streaming is opened, it will be connected automatically upon startup 2. The port number must be set above 1024 <Remark> The following port has been used by the camera. Setting of the port may not connect correctly 8554, 8556, 8557, 8080, 9090, 1935 3. Delay time is for 20 to 8000 microseconds. The default value is 120 microseconds
5	Streaming Setting	 <ul style="list-style-type: none"> ■ Streaming Mode: Choose from Single/Dual stream ■ Encode: Set encode format as MJPEG (Single)/ H.264+H.264(Dual)/ H.264+MJPEG(Dual) ■ Resolution: Set Resolution ■ Rate Control: Setting according to the supported resolution ■ Bit rate: <ul style="list-style-type: none"> ➢ Streaming 1: Support 64 ~ 20,000 kbps ➢ Streaming 2: Support 64 ~ 8,000 kbps ■ Rate Control: CBR/ VBR

5.2.5.1 SVC description:

Link Address <rtsp://VC IP Address:Port/h264>

- 60Frame: <rtsp://VC IP Address:8557/h264>, E.g.: <rtsp://192.168.100.150:8557/h264>
- 30Frame: <rtsp://VC IP Address:8601/h264>, E.g.: <rtsp://192.168.100.150:8601/h264>
- 15Frame: <rtsp://VC IP Address:8602/h264>, E.g.: <rtsp://192.168.100.150:8602/h264>
- 7Frame: <rtsp://VC IP Address:8603/h264>, E.g.: <rtsp://192.168.100.150:8603/h264>
- 3Frame: <rtsp://VC IP Address:8604/h264>, E.g.: <rtsp://192.168.100.150:8604/h264>

5.2.6 System Settings - Device

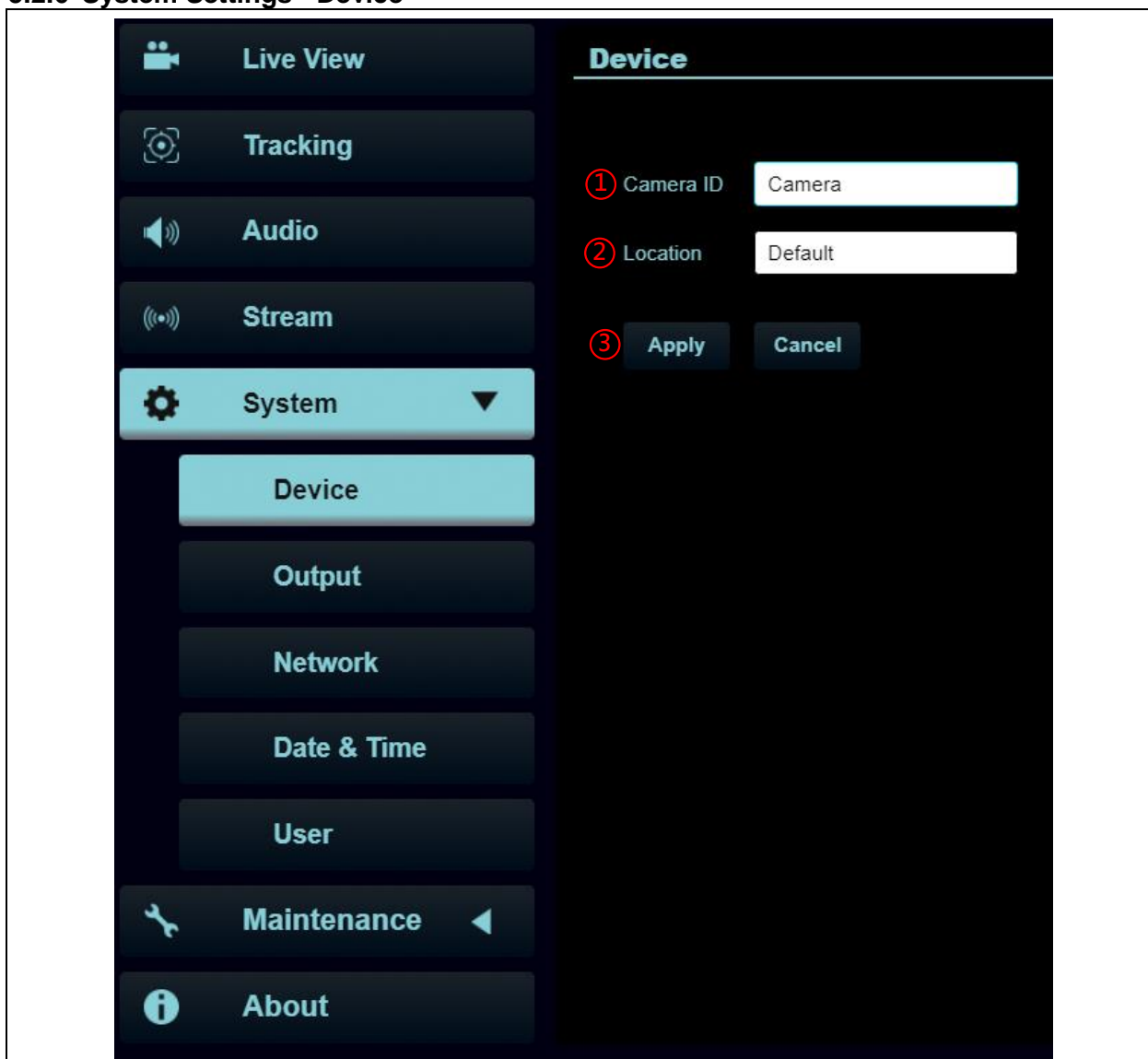

No	Item	Function Descriptions
1	Camera ID	<p>Change camera ID here</p> <ul style="list-style-type: none"> ■ Supporting 1 - 30 characters for the camera ID ■ Please mix uppercase and lowercase letters or numbers for characters. Special symbols such as “/” and “space” cannot be used <p><Remark> Modifying this field will modify the Onvif device name synchronously</p>
2	Location	<p>Modify the location of the camera, such as Room 1</p> <ul style="list-style-type: none"> ■ Supporting 1 - 30 characters for the camera location ■ Please mix uppercase and lowercase letters or numbers for characters. Special symbols such as “/” and “space” cannot be used <p><Remark> Modifying this field will modify the Onvif device name synchronously</p>
3	Apply/Cancel	After the setting has been modified, select this button to apply the setting

5.2.7 System Settings – Output

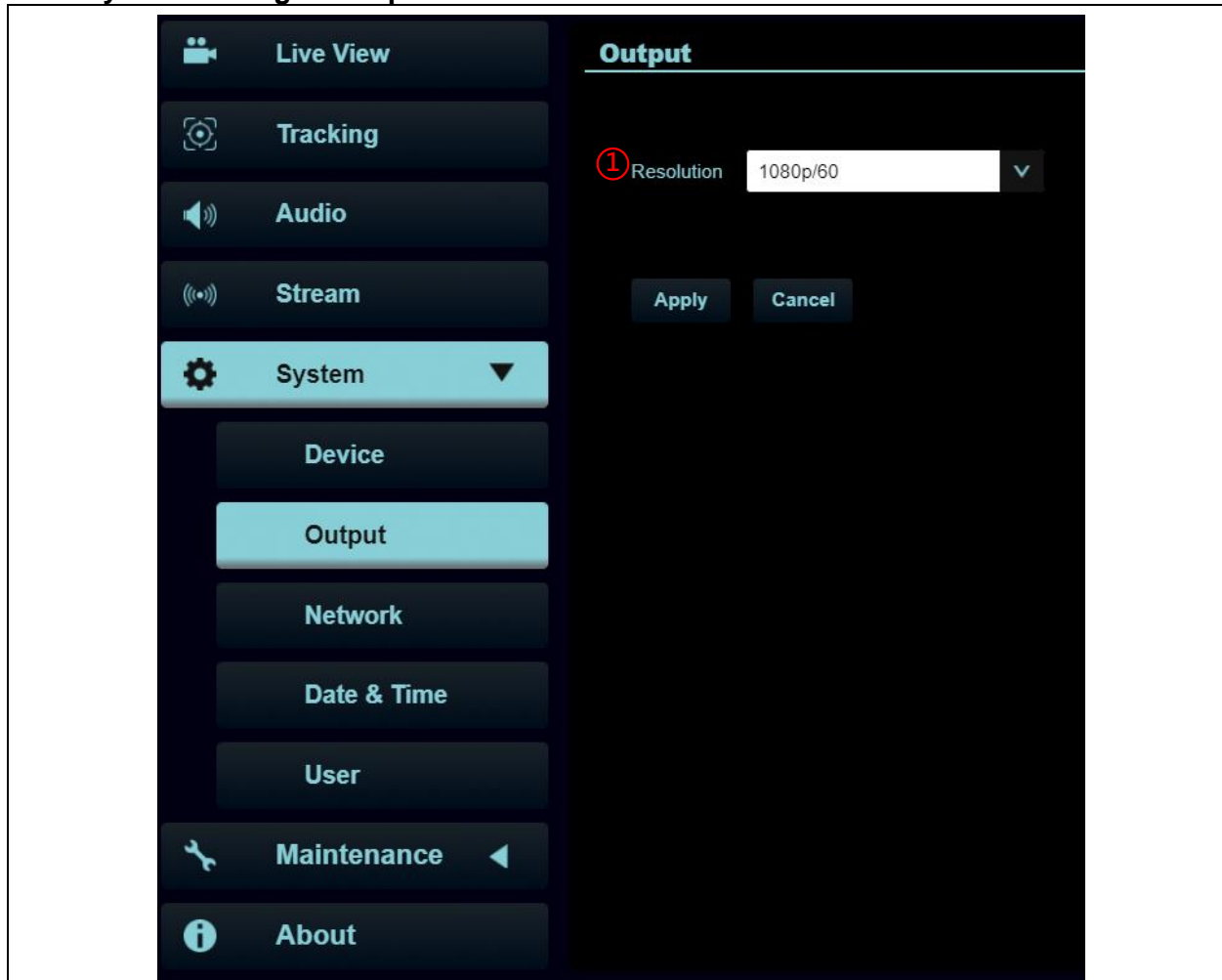

No	Item	Function Descriptions
1	Resolution	Set output resolution

5.2.8 System Settings – Network

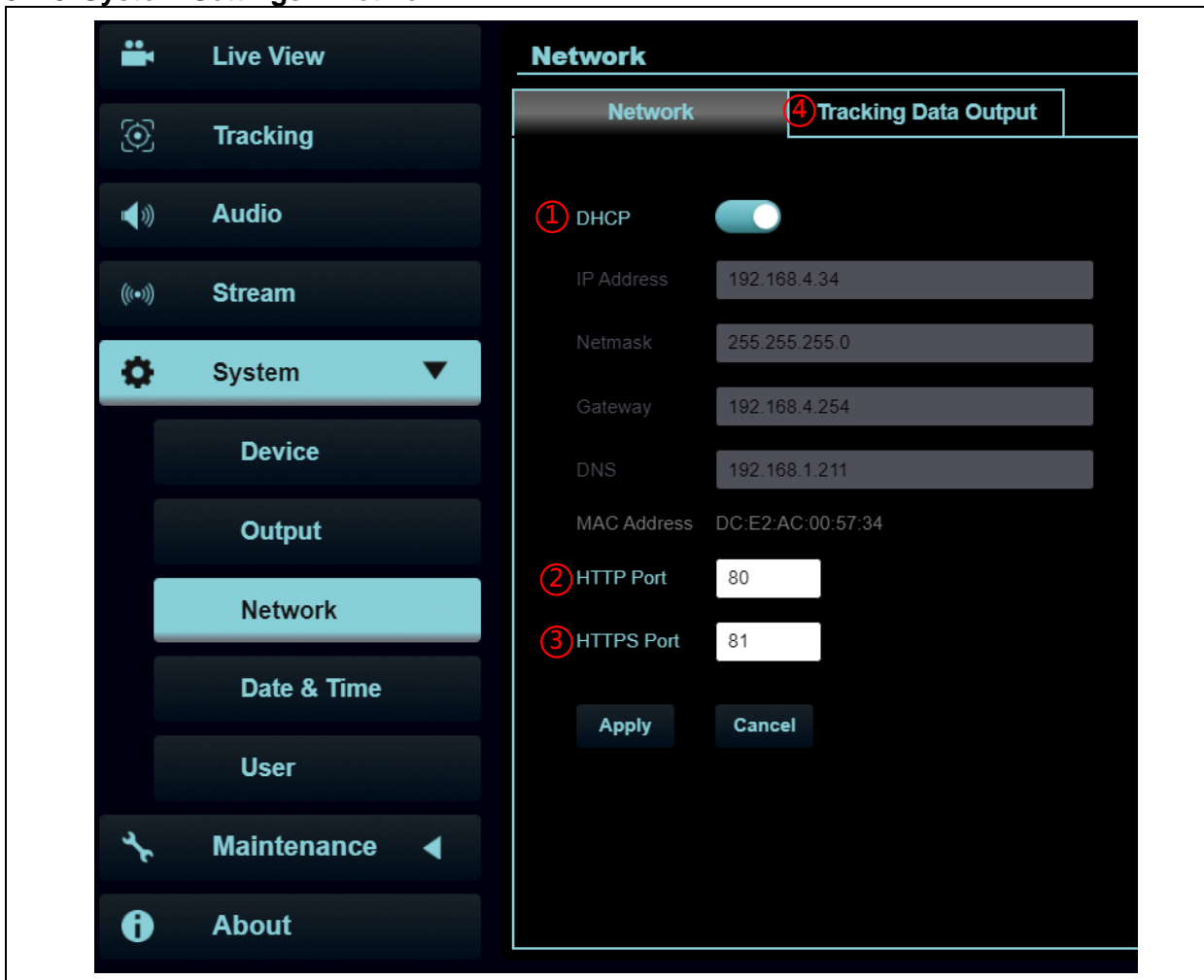

No	Item	Function Descriptions
1	DHCP	Network setting of camera. Change of setting is available when DHCP function is closed
2	HTTP port	Set HTTP port. The default Port value is 80
3	HTTPS port	Set HTTPS port. The default Port value is 81
4	Tracking Data Output	<div data-bbox="544 1402 1246 1776" data-label="Image"> </div> <p>When enabled, PTZ position information can be reported when the camera moves</p> <ol style="list-style-type: none"> 1. Serial Output: Please set the protocol to VISCA and the baud rate to 38400 2. IP output: Set the destination IP address and port <p><Remark> When Tracking Data Output is enabled, the camera performance may be affected.</p>

5.2.9 System Settings - Date & Time

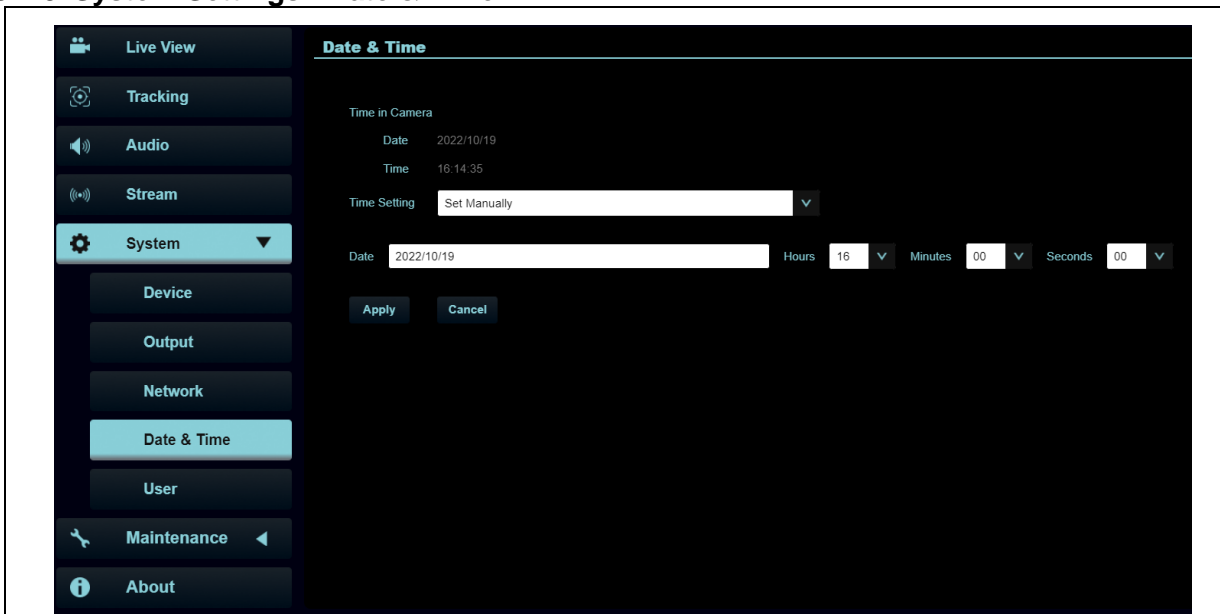

Function Descriptions

Display date and time of the current camera/PC. You may set the synchronization method and modify date and time

5.2.10 System Settings - User

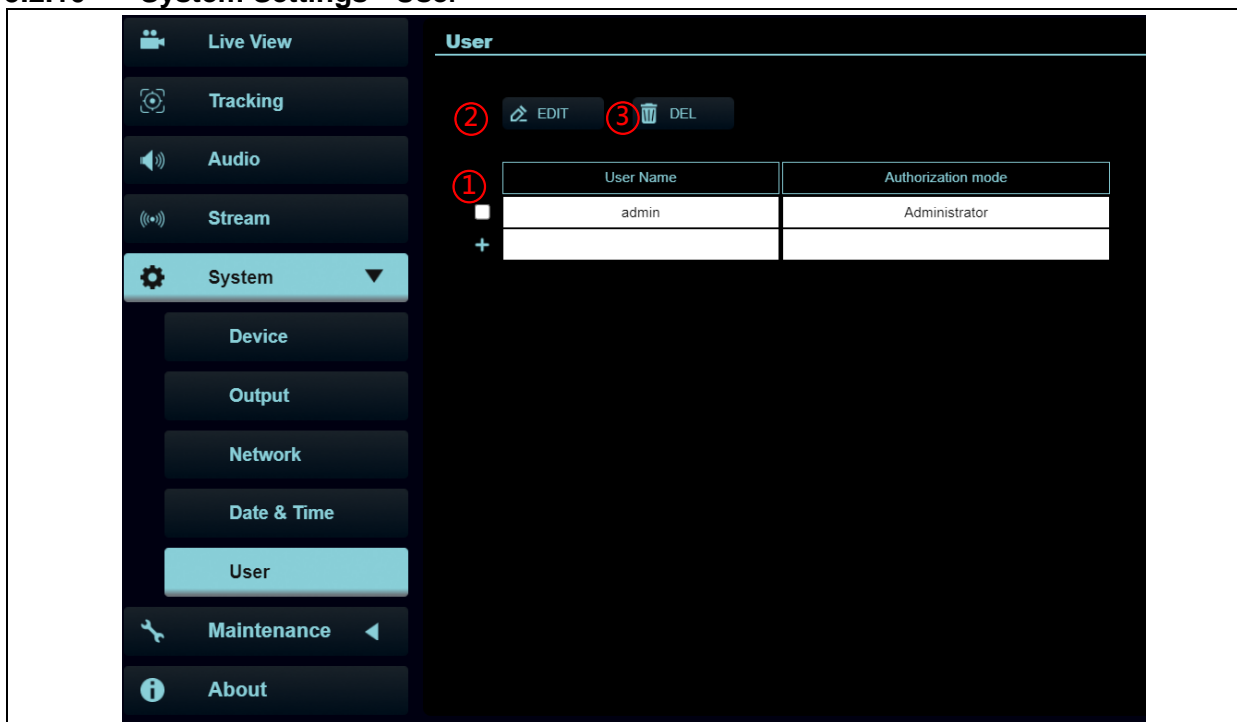

No	Item	Function Descriptions
1	Add	Enter a user name and password to add a new user
2	Edit	Select the user account to be modified and click EDIT to edit the password and authorization mode
3	Delete	Select the user account to be deleted and click DEL to delete the account
<ul style="list-style-type: none"> ■ Enter a user name and password to add a new user <ul style="list-style-type: none"> ➢ Supporting 4 - 32 characters for user name and password ➢ Please mix uppercase and lowercase letters or numbers for characters. Special symbols or the underlined cannot be used ➢ Support up to 16 groups of user accounts 		

■ Authentication Mode: Set the new account management permissions

User Type	Admin	Operator	Viewer
View images	V	V	V
Settings	V	V	X
Account management	V	X	X

<Remark> When Factory Reset is executed, it will clear the user's data

5.2.11 Maintenance-Service

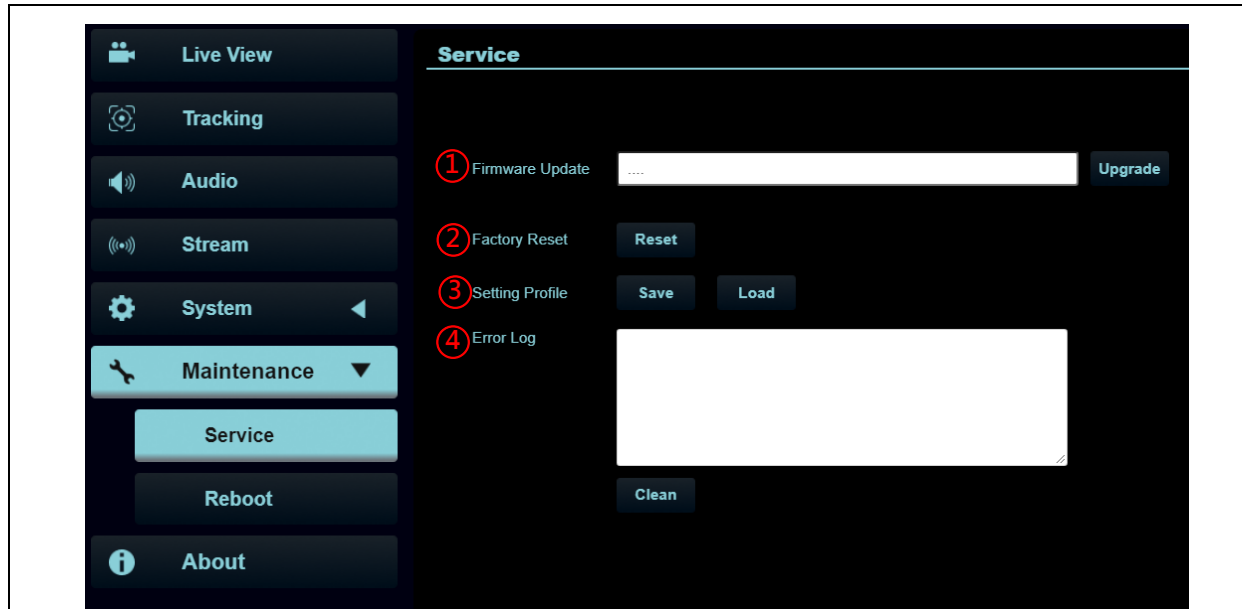

No	Item	Function Descriptions
1	Firmware Upgrade	Select the firmware file, and click [Upgrade] to update the firmware <Remark> Update takes about 1 - 2 minutes <Note> Please do not operate or turn off the power of the device during the update to avoid firmware update failure
2	Factory Reset	Restore the factory default setting
3	Setting Profile	Save setup parameters as a Profile, and users can download and upload camera setup parameters
4	Error Log	If the machine operates abnormally, the error log can be exported for reference of Lumens technicians <Remark> When an error code appears, please try to clear it to make sure whether the issue has occurred repetitively

5.2.12 Maintenance-Reboot

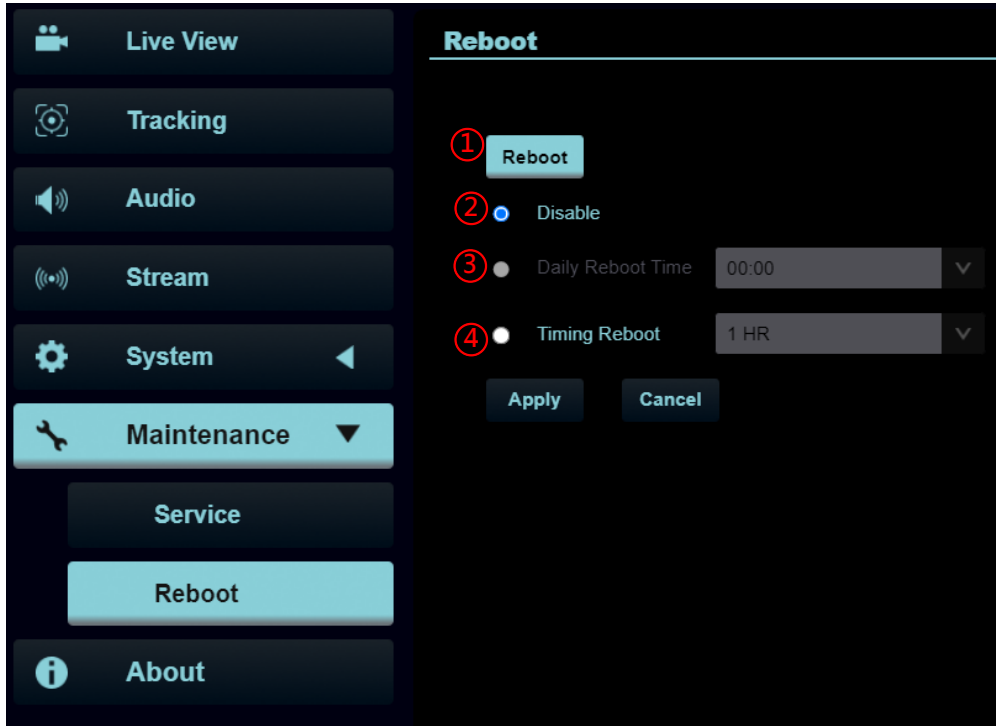

No	Item	Function Descriptions
1	Reboot	Reboot immediately
2	Disable	Disable the reboot settings
3	Daily reboot	Set the daily reboot time <Note> Please go to Settings - Time to complete the SNTP server synchronization to set daily reboot
4	Timing Reboot	Set the timing reboot time

5.2.13 About



Function Descriptions

Display the firmware version, serial number, running time and other related information of the camera
For technical support, please scan the QR code at the bottom right

Chapter 6 DIP Switch Setting

6.1 OUTPUT Switch



Output Mode	Setting	Output Mode	Setting
1920x1080/60p		1920x1080/50p	
1920x1080/30p		1920x1080/25p	
1920x1080/60i		1920x1080/50i	
1280x720/60p		1280x720/50p	
1080/59.94p		1080/59.94i	
1080/29.97p		720/59.94p	

6.2 IR SELECT



ID	Setting
1	
2	
3	

6.3 Camera Address Selector



Setting	Function Descriptions
0~7	ID 0~7
8~9	Reserved

6.4 System Switch



Setting	功能説明
DIP 1	RS-232/RS-422 Communication Control OFF: RS-232 / ON: RS-422
DIP 2	IR signal output OFF: Off / ON: On
DIP 3	Communication baud rate OFF: 9600 / ON : 38400
DIP 4	Reserved

Chapter 7 Troubleshooting

This chapter describes problems you may encounter while using VC-TA50. If you have questions, please refer to related chapters and follow all the suggested solutions. If the problem still occurred, please contact your distributors or the service center.

No.	Problems	Solutions
1.	Boot without power signal	<ol style="list-style-type: none"> 1. Make sure you have plugged in the power cord. 2. When using a PoE connection, ensure that the power supply supports POE+ (IEEE 802.3at) hubs.
2.	There is no image output from camera	<ol style="list-style-type: none"> 1. Check the power supply or PoE supply functions. 2. Confirm the output signals are in streaming output. 3. Confirm whether the camera resolution can be used together with the monitor equipment. 4. Replace the cables and make sure they are not faulty.
3.	Camera image is severely delayed	Please use 1080p or 720p 60/ 50 fps rather than 25/ 30 fps signals.
4.	RS-232 cannot be controlled	<ol style="list-style-type: none"> 1. Confirm the connection is correct (RS-232 In/Out). 2. Please make sure the Baud rate setting is the same as the control equipment.
5.	Whether the Internet can be used for operation	Please refer to Chapter 5 Network Function Setting Description for the Internet usage
6.	The ONVIF software cannot find the machine	Please make sure that [Setting] > [Video] > [Camera ID] / [Location] in the web page uses only English letters or numbers. The ONVIF software cannot find the machine if you use special characters and space.
7.	Tally lamp is not working when applying RS232 setting	Please make sure if the Tally lamp function is enabled from the setting menu or web page. Setting Menu: [System] > [Tally Lamp]
8.	The camera does not save the relevant parameters (PTZ, AWB ...) after reboot	Please make sure if the Initial Position is set to Last Operated Position from the setting menu or web page Setting Menu: [System] > [Initial Position]
9.	When tracking, the person moves out of the frame and is lost	<ul style="list-style-type: none"> ■ Confirm that the person tracking is set to half body or full body tracking. Because the number of samples for half body tracking is small, the full body tracking is more accurate than the half body tracking. ■ Walking speed may affect the tracking performance. The normal walking speed has better tracking performance. Make sure if the walking speed is too fast to be tracked.
10.	How to log in the portal when you forget your account password	Please contact your Lumens distributor or service center.
11.	The tracking person suddenly squats down and the camera stops tracking	When the person squats down and stands up again, there is a chance that the camera will stop tracking. The lens will zoom out first, and then zoom in after recognizing the target. This is a normal behavior

Chapter 8 Safety Instructions

Always follow these safety instructions when setting up and using this product:

1 Operation

- 1.1 Please use the product in the recommended operating environment, away from water or source of heat.
- 1.2 Do not place the product on a tilted or unstable trolley, stand or table.
- 1.3 Please clean the dust on the power plug prior to usage. Do not insert the product's power plug into a multiplug to prevent sparks or a fire.
- 1.4 Do not block the slots and openings in the case of the product. They provide ventilation and prevent the product from overheating.
- 1.5 Do not open or remove covers, otherwise it may expose you to dangerous voltages and other hazards. Refer all servicing to licensed service personnel.
- 1.6 Unplug the product from the wall outlet and refer servicing to licensed service personnel when the following situations happen:
 - If the power cords are damaged or frayed.
 - If liquid is spilled into the product or the product has been exposed to rain or water.

2 Installation

- 2.1 For security considerations, please make sure the standard mount you use is in line with UL or CE safety approbations and installed by technician personnel approved by agents.

3 Storage

- 3.1 Do not place the product where the cord can be stepped on as this may result in fraying or damage to the lead or the plug.
- 3.2 Unplug this product during thunderstorms or if it is not going to be used for an extended period.
- 3.3 Do not place this product or accessories on top of vibrating equipment or heated objects.



4 Cleaning

- 4.1 Disconnect all the cables prior to cleaning and wipe the surface with a dry cloth. Do not use alcohol or volatile solvents for cleaning.

5 Batteries (for products or accessories with batteries)

- 5.1 When replacing batteries, please only use similar or the same type of batteries.
- 5.2 When disposing of batteries or products, please adhere to the relevant instructions in your country or region for disposing of batteries or products.

■ Precautions

	This symbol indicates that this equipment may contain dangerous voltage which could cause electric shock. Do not remove the cover (or back). No user-serviceable parts inside. Refer servicing to licensed service personnel.		This symbol indicates that there are important operating and maintenance instructions in this User Manual with this unit.
---	---	--	---

■ FCC Warning

This equipment has been tested and found to comply with the limits for a Class A digital device, pursuant to part 15 of the FCC Rules. These limits are designed to provide reasonable protection against harmful interference when the equipment is operated in a commercial environment.

Notice :

The changes or modifications not expressly approved by the party responsible for compliance could void the user's authority to operate the equipment..

This equipment has been tested and found to comply with the limits for a Class A digital device, pursuant to part 15 of the FCC Rules. These limits are designed to provide reasonable protection against harmful interference when the equipment is operated in a commercial environment.

■ IC Warning

This digital apparatus does not exceed the Class A limits for radio noise emissions from digital apparatus as set out in the interference-causing equipment standard entitled "Digital Apparatus," ICES-003 of Industry Canada.

Cet appareil numérique respecte les limites de bruits radioélectriques applicables aux appareils numériques de Classe A prescrites dans la norme sur le matériel brouilleur: "Appareils Numériques," NMB-003 édictée par l'Industrie.

■ EN55032 CE Warning

Operation of this equipment in a residential environment could cause radio interference.

Warning: Operation of this equipment in a residential environment may cause radio interference

Supplier's Declaration of Conformity

47 CFR § 2.1077 Compliance Information

Manufacturer : Lumens Digital Optics Inc.

Product Name : VC-TA50

Model Number : PTZ Video Camera

Responsible Party – U.S. Contact Information

Supplier : Lumens Integration, Inc.

4116 Clipper Court, Fremont, CA 94538, United States

e-mail : support@mylumens.com

FCC Compliance Statement

This device complies with Part 15 of the FCC Rules. Operation is subject to the following two conditions : (1) This device may not cause harmful interference, and (2) this device must accept any interference received, including interference that may cause undesired operation.

Copyright Information

Copyrights © Lumens Digital Optics Inc. All rights reserved.

Lumens is a trademark that is currently being registered by Lumens Digital Optics Inc.

Copying, reproducing or transmitting this file is not allowed if a license is not provided by Lumens Digital Optics Inc. unless copying this file is for the purpose of backup after purchasing this product.

In order to keep improving the product, the information in this file is subject to change without prior notice.

To fully explain or describe how this product should be used, this manual may refer to names of other products or companies without any intention of infringement.

Disclaimer of warranties: Lumens Digital Optics Inc. is neither responsible for any possible technological, editorial errors or omissions, nor responsible for any incidental or related damages arising from providing this file, using, or operating this product.